

Kit 1099

FIAT Panda, 5-dr Hatchback, 03-

480R
754

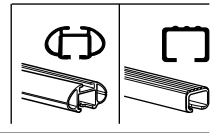
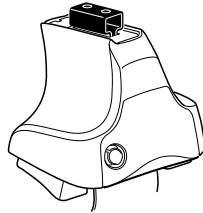

480

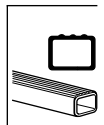
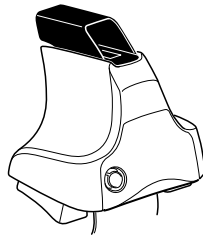

750

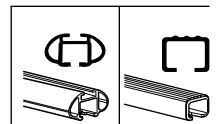
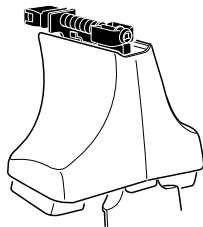

Kit

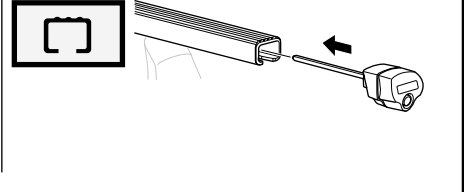
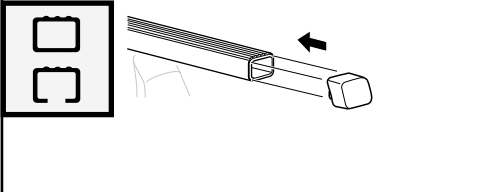
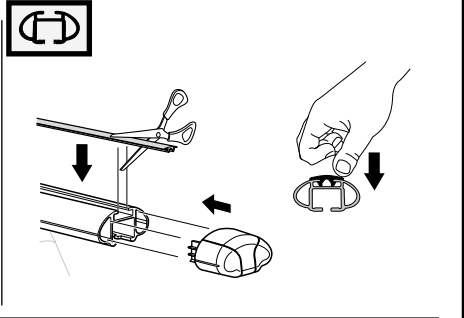
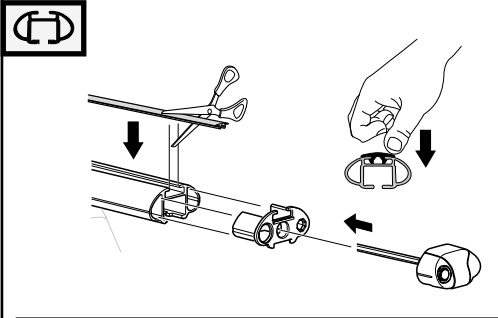
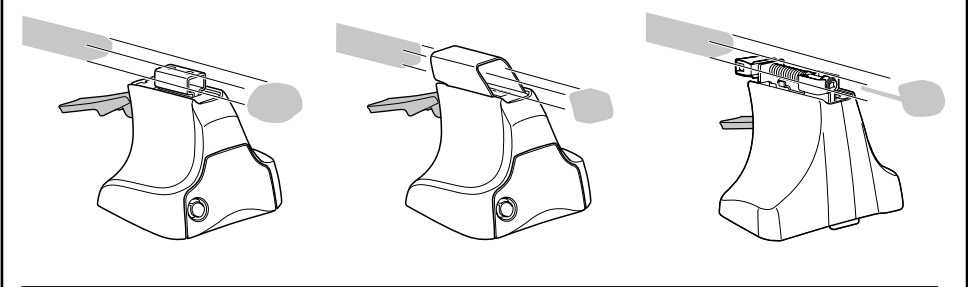
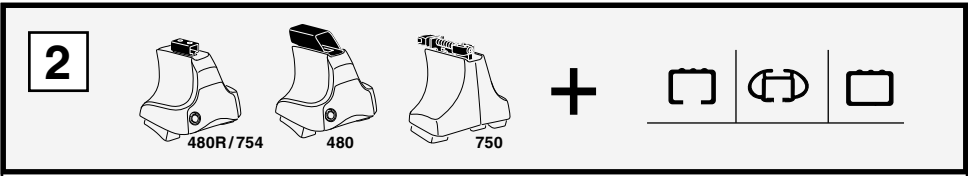
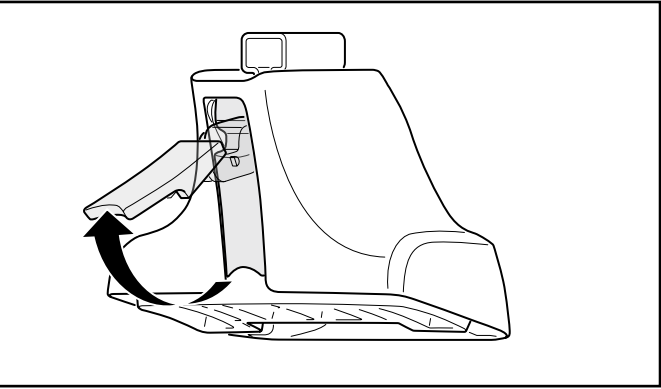
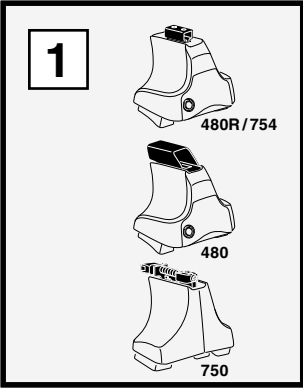

3

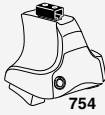

754

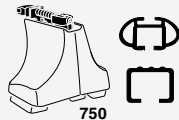

750

1

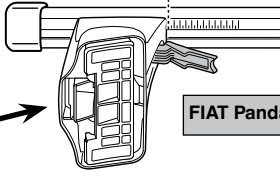
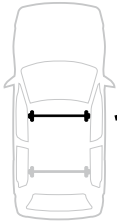

2

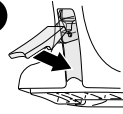

FIAT Panda, 5-dr Hatchback, 03-

X

29

1

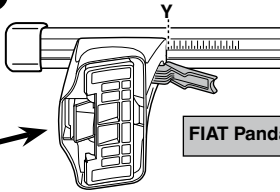

2

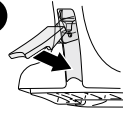

FIAT Panda, 5-dr Hatchback, 03-

Y

26



480R



480

1

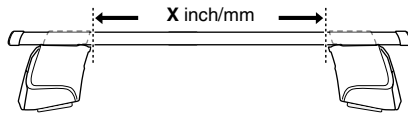
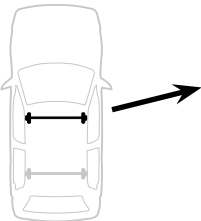

2

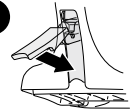

FIAT Panda, 5-dr Hatchback, 03-

X inch

X mm

37"

941 mm

1

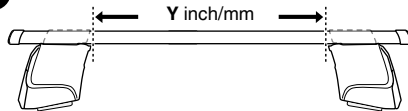
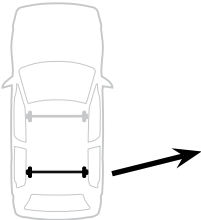

2

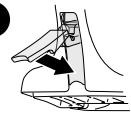

FIAT Panda, 5-dr Hatchback, 03-

Y inch

Y mm

35 7/8"

911 mm

4

FIAT Panda, 5-dr Hatchback, 03-

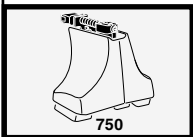
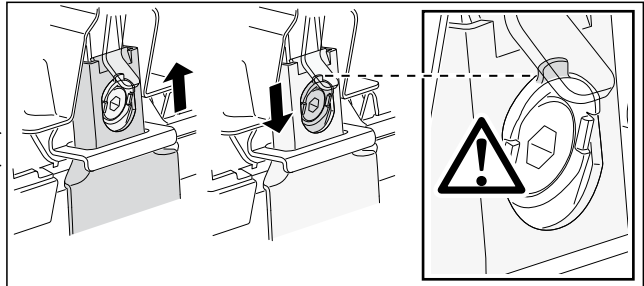
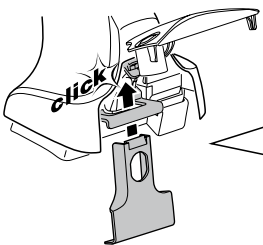
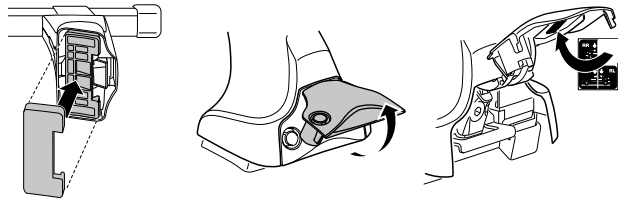
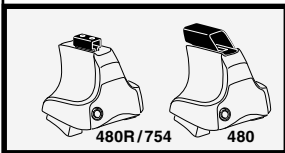
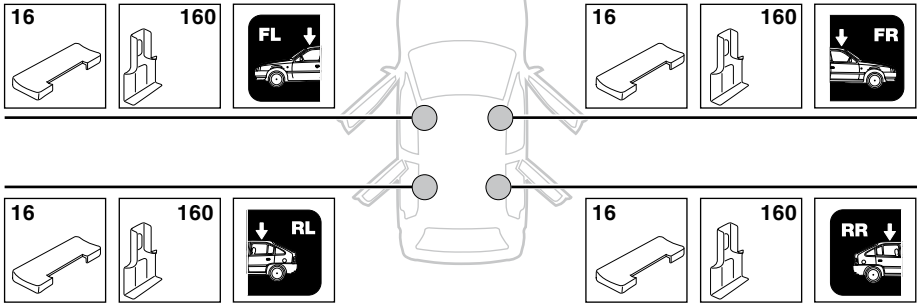

5



	X mm	Y mm	X inch	Y inch
FIAT Panda, 5-dr Hatchback, 03-	750 mm	1015 mm	29 1/2"	40"

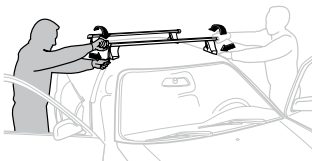
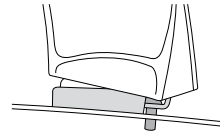
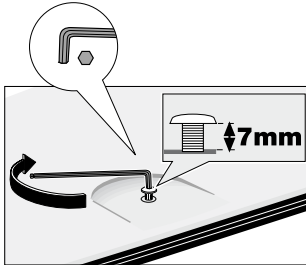
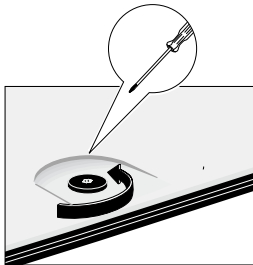
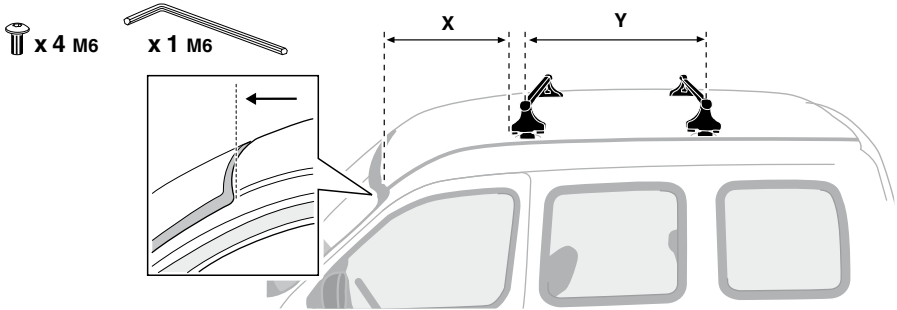

- GB/US** Tighten alternately
D Die Schrauben abwechselnd anziehen
F Serrer alternativement chaque côté
NL Afwisselend aan de linker- en de rechterkant aandraaien
I Alternare il serraggio delle viti
E Apretar alternativamente
PT Aperte alternadamente
S Dra åt växelvis
FIN Kierrä vuorotellen
EST Pinguldage vaheldumisi
LAT Pievelciēt pamišus
LIT Užsukinėkite pakaitomis
PL Śruby dokręcaj naprzemiennie
RU Затягивайте попеременно

- CZ** Pokrétla bagazníka dokręcaj dokręcaj naprzemiennie.
SK Dofahujte striedavo
SLO Privijajte izmenično.
HR Naizmjenično zategnite
HU Egyarástól függetlenül szorítandó
GR Σφιγγετε εναλλάξ
TR Dönüşümlü sıkın

中文 交替拧紧

한국어 번갈아 가며 조이십시오.

日本語 交互に締め付けてください。

ไทย ขึ้นในแบบสลับ

6

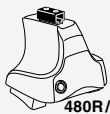

480R/754



480

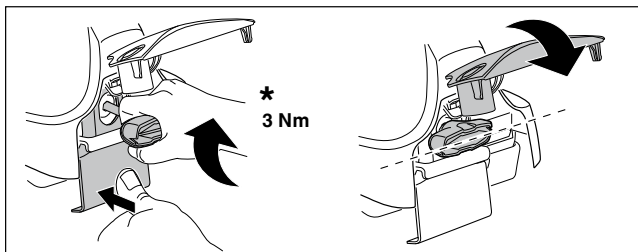
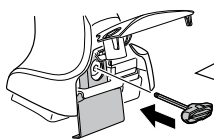

*
3 Nm

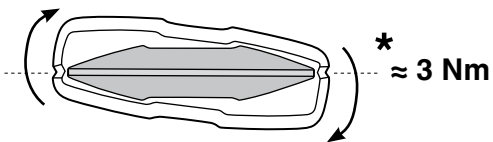
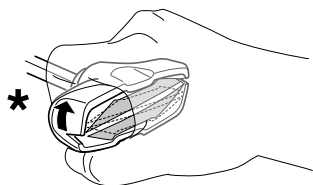

*
≈ 3 Nm

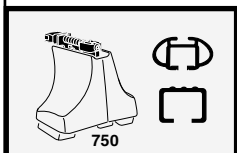
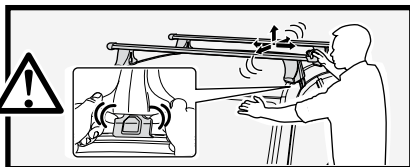

750

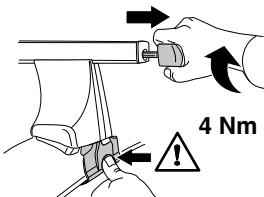

4 Nm

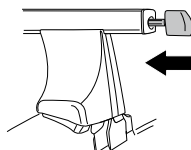

7



x1
17 mm

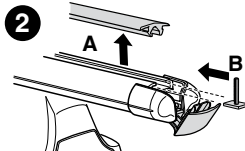
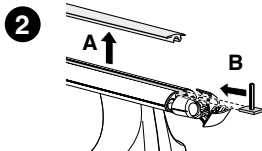
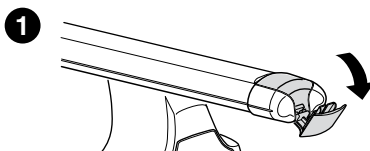
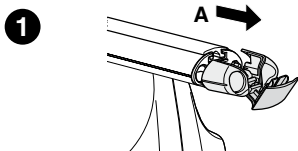
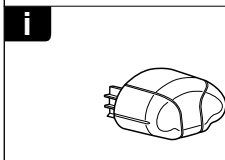
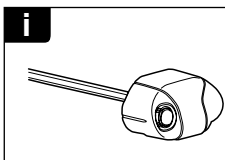
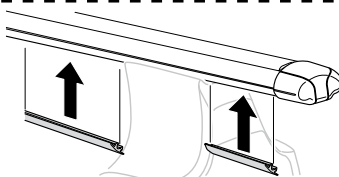



THULE
SWEDEN
**ONE
KEY
SYSTEM**



- 544 (x4)
- 596 (x6)
- 588 (x8)
- NA 510 (x10)
- EUR 452 (x12)
- ASIA



WW ▶ Thule Sweden AB, Box 69, 330 33 Hillerstorp, SWEDEN
NA ▶ Thule Inc., 42 Silvermine Road, Seymour, Connecticut 06483, USA

info@thule.com
customer.service@thule.com

www.thule.com