

# Kit 1258

NISSAN Primera (P12), 4-dr Sedan, 02-07

NISSAN Primera (P12), 5-dr Hatchback, 02-07

NISSAN Primera (W12), 5-dr Estate, 02-07

480R  
754

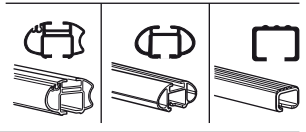
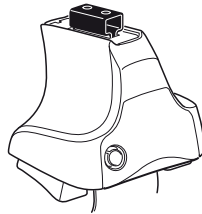

480

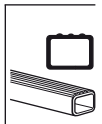
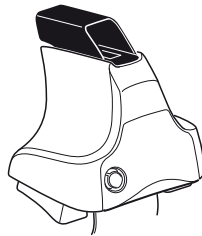

750

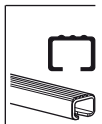
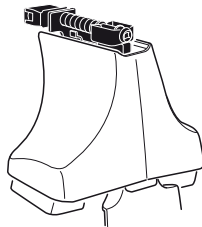

**Kit**

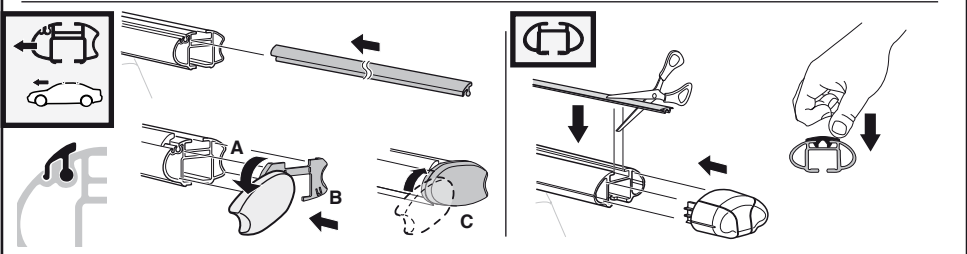
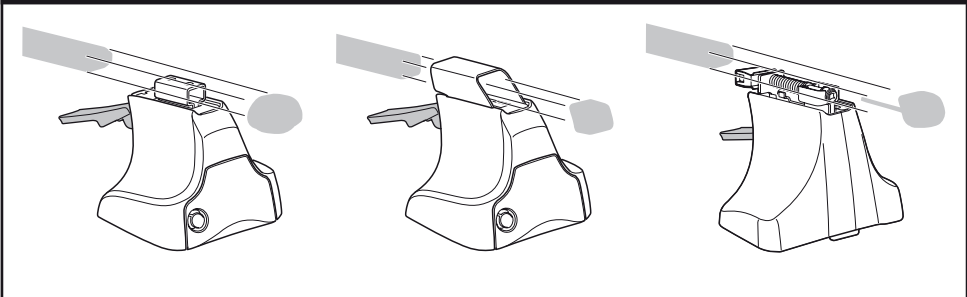

**3**



754

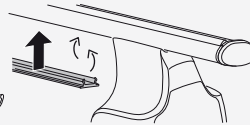
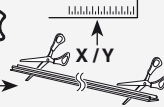

750

**1**

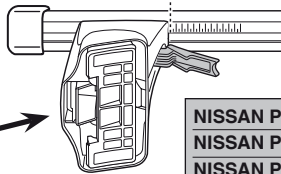
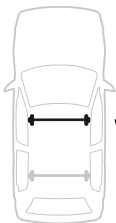

**2**

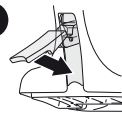

	X
<b>NISSAN Primera (P12), 4-dr Sedan, 02-07</b>	<b>32</b>
<b>NISSAN Primera (P12), 5-dr Hatchback, 02-07</b>	<b>31,5</b>
<b>NISSAN Primera (W12), 5-dr Estate, 02-07</b>	<b>31,5</b>

**1**

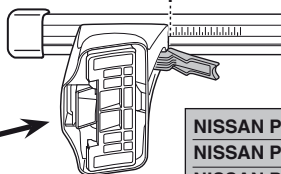

**2**

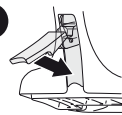

	Y
<b>NISSAN Primera (P12), 4-dr Sedan, 02-07</b>	<b>33</b>
<b>NISSAN Primera (P12), 5-dr Hatchback, 02-07</b>	<b>32,5</b>
<b>NISSAN Primera (W12), 5-dr Estate, 02-07</b>	<b>31,5</b>



480R



480

**1**

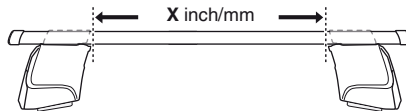

**2**

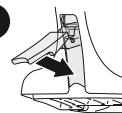

	X inch	X mm
<b>NISSAN Primera (P12), 4-dr Sedan, 02-07</b>	<b>38 1/4"</b>	<b>971 mm</b>
<b>NISSAN Primera (P12), 5-dr Hatchback, 02-07</b>	<b>38"</b>	<b>966 mm</b>
<b>NISSAN Primera (W12), 5-dr Estate, 02-07</b>	<b>38"</b>	<b>966 mm</b>

**1**

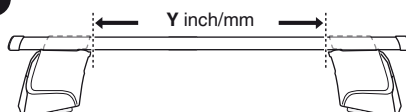

**2**

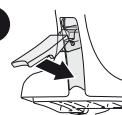

	Y inch	Y mm
<b>NISSAN Primera (P12), 4-dr Sedan, 02-07</b>	<b>38 5/8"</b>	<b>981 mm</b>
<b>NISSAN Primera (P12), 5-dr Hatchback, 02-07</b>	<b>38 3/8"</b>	<b>976 mm</b>
<b>NISSAN Primera (W12), 5-dr Estate, 02-07</b>	<b>38"</b>	<b>966 mm</b>

4

NISSAN Primera (P12), 4-dr Sedan, 02-07  
NISSAN Primera (P12), 5-dr Hatchback, 02-07

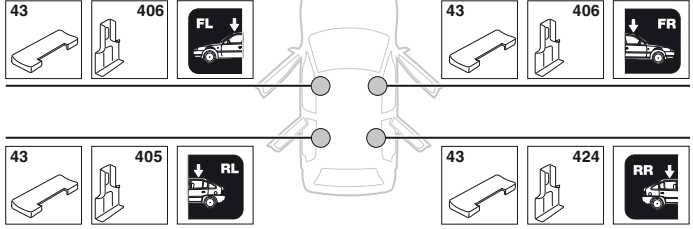

NISSAN Primera (W12), 5-dr Estate, 02-07

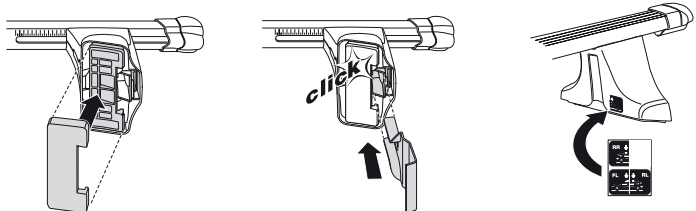
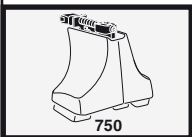
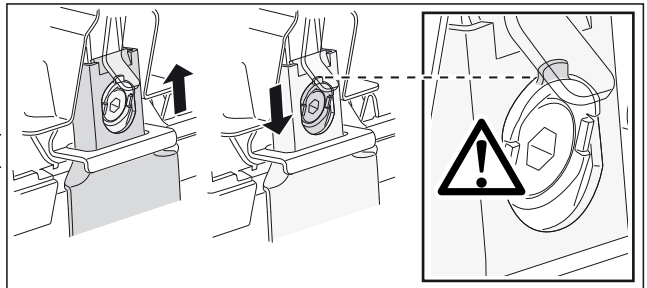
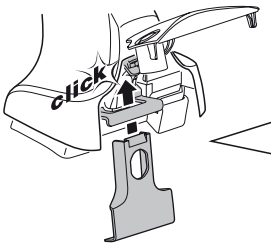
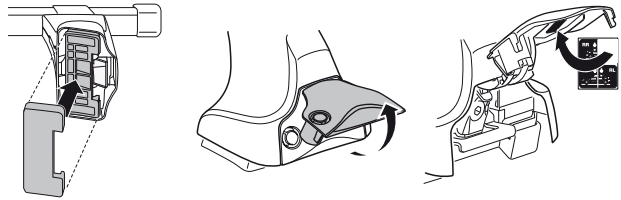
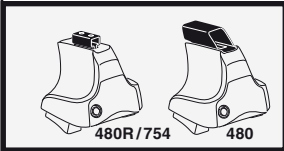
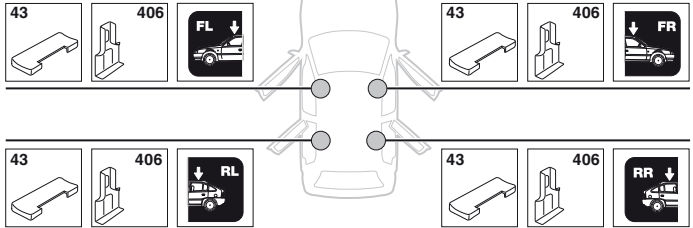

5

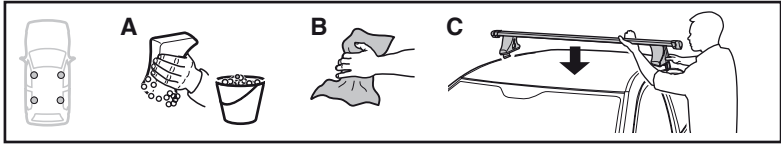

	X mm	Y mm	X inch	Y inch
NISSAN Primera (P12), 4-dr Sedan, 02-07	290 mm	660 mm	11 <sup>3</sup> / <sub>8</sub> "	26 "
NISSAN Primera (P12), 5-dr Hatchback, 02-07	290 mm	660 mm	11 <sup>3</sup> / <sub>8</sub> "	26 "
NISSAN Primera (W12), 5-dr Estate, 02-07	300 mm	700 mm	11 <sup>3</sup> / <sub>4</sub> "	27 <sup>1</sup> / <sub>2</sub> "

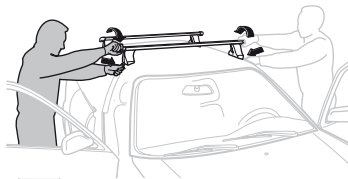
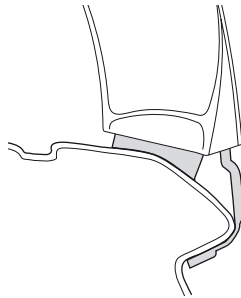
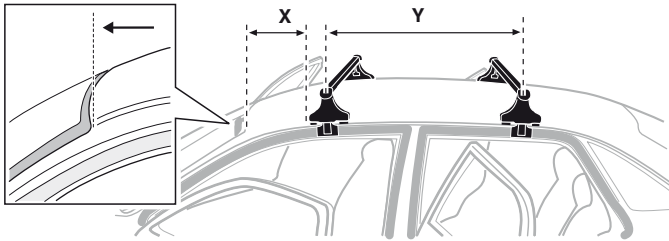

**GB/US** Tighten alternately

**D** Die Schrauben abwechselnd anziehen

**F** Serrer alternativement chaque côté

**NL** Afwisselend aan de linker- en de rechterkant aandraaien

**I** Alternare il serraggio delle viti

**E** Apretar alternativamente

**PT** Aperte alternadamente

**S** Dra åt växelvis

**FIN** Kierrä vuorotellen

**EST** Pinguldage vaheldumisi

**LAT** Pielvelciēt pamīšus

**LIT** Užsukinėkite pakaitomis

**PL** Śruby dokręcaj naprzemiennie

**RU** Затягивайте попеременно

**CZ** Pokręťta bagażníka dokręcaj dokręcaj naprzemiennie.

**SK** Doťahujte striedavo

**SLO** Privijajte izmenično.

**HR** Naizmjenično zategnite

**HU** Egymástól függetlenül szorítandó

**GR** Σφίγγετε εναλλάξ

**TR** Dönüşümlü sıkın

**中文** 交替拧紧

**한국어** 번갈아 가며 조이십시오.

**日本語** 交互に締め付けてください。

**ไทย** ชั้โน้แบบสลับ

6



480R/754



480

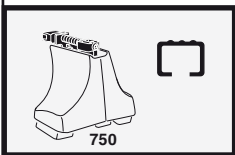
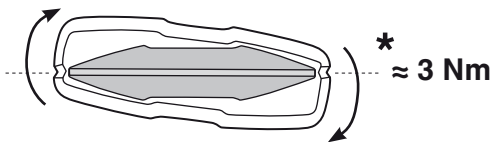
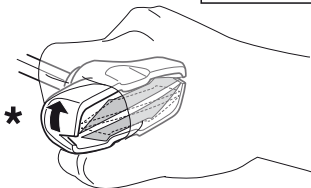
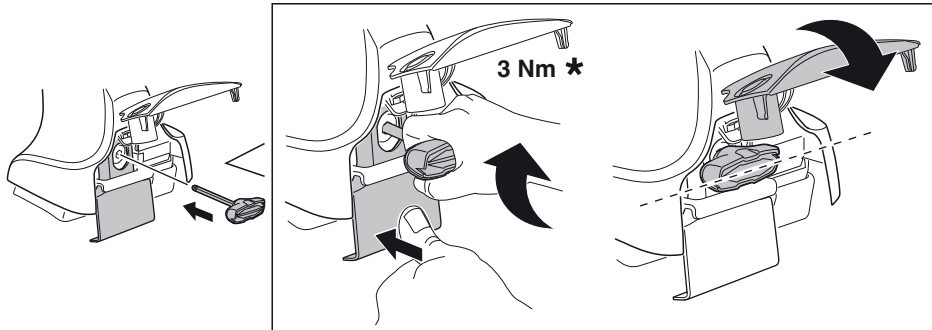

750

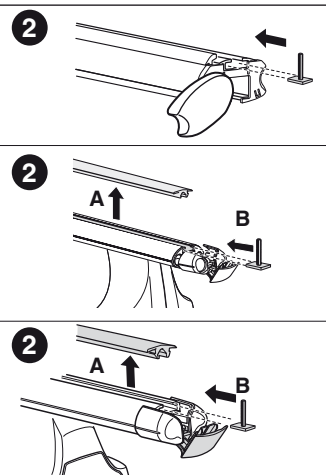
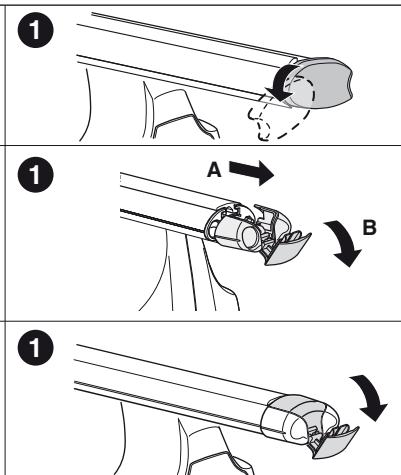
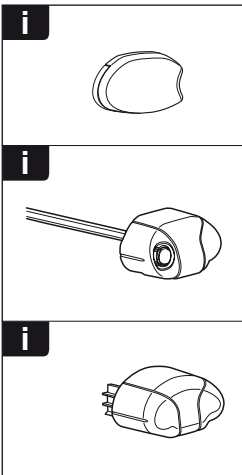
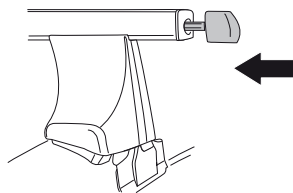
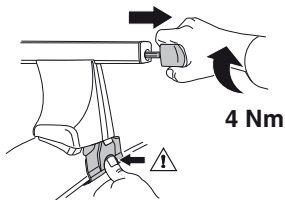

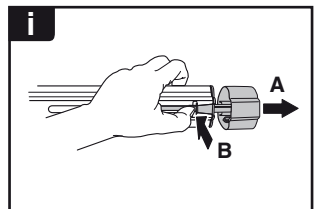
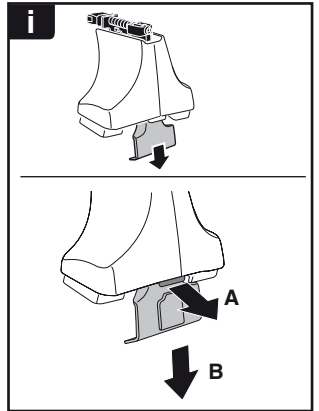
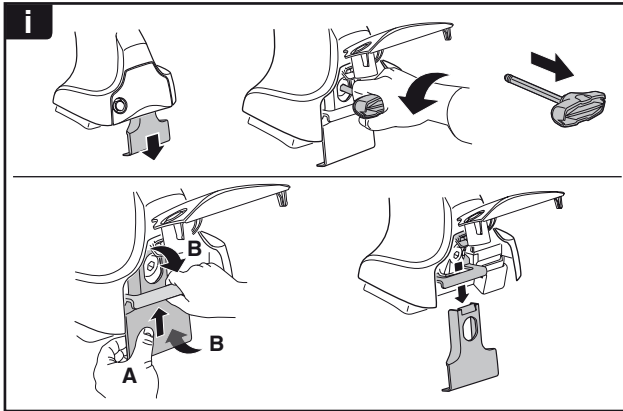
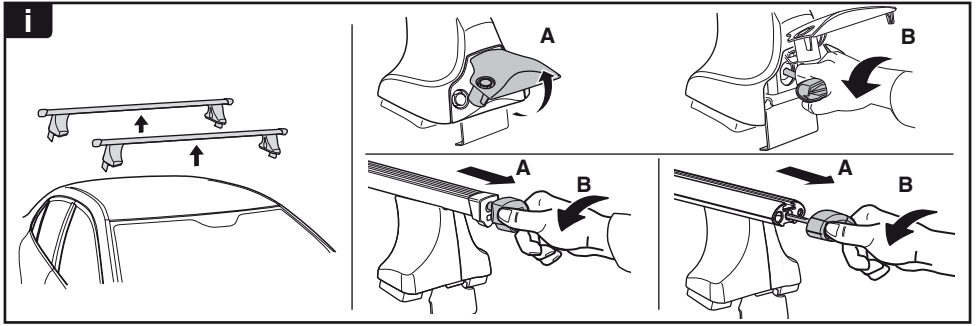

**THULE**  
SWEDEN  
**ONE  
KEY  
SYSTEM**

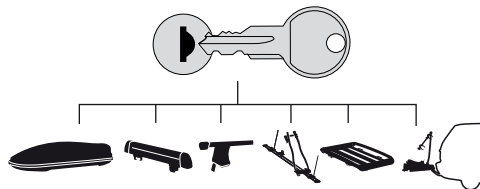

- 544 (x4)
- 596 (x6)
- 588 (x8)
- NA 510 (x10)
- EUR 452 (x12)
- ASIA

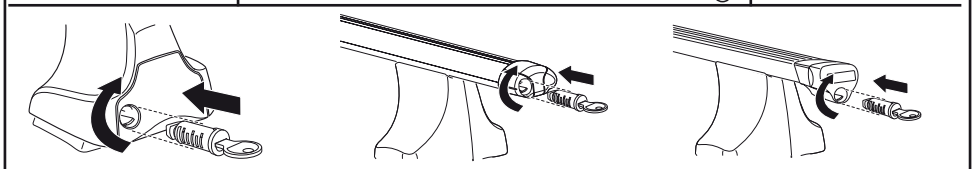

WW ▶ Thule Sweden AB, Box 69, 330 33 Hillerstorp, SWEDEN  
NA ▶ Thule Inc., 42 Silvermine Road, Seymour, Connecticut 06483, USA

info@thule.com  
customer.service@thule.com

www.thule.com