

Kit 1359

CHEVROLET Niva, 5-dr SUV, 03-
LADA 119, 5-dr Hatchback, 05- (FIN)
LADA Kalina 1119, 5-dr Hatchback, 05-

480R
754

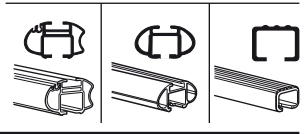
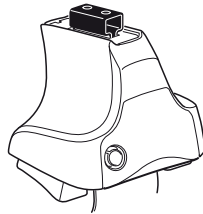

480

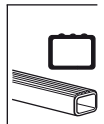
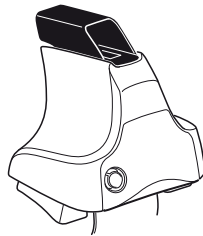

750

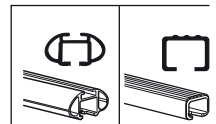
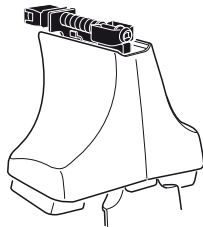

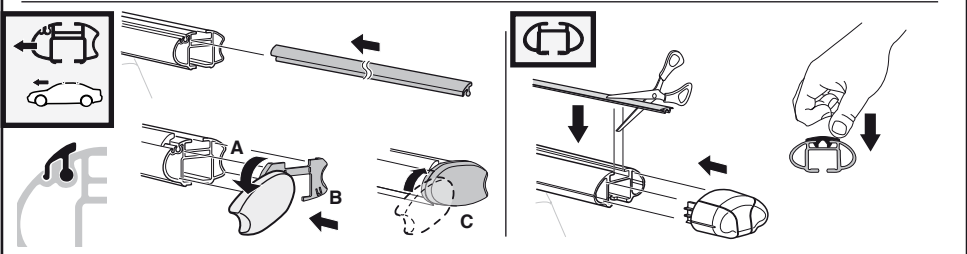
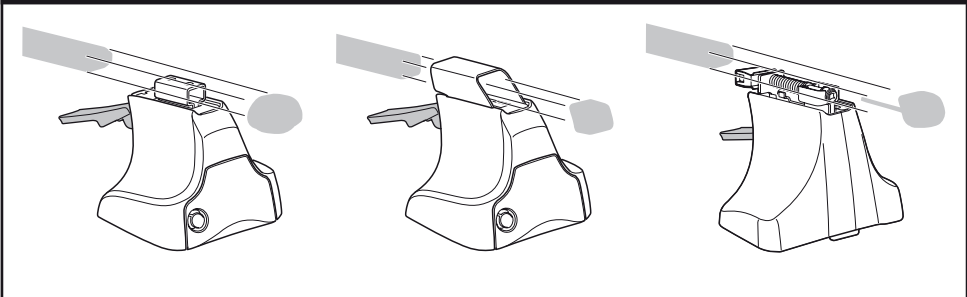

3

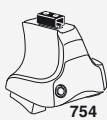

754

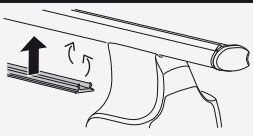
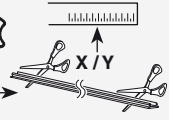

750

1

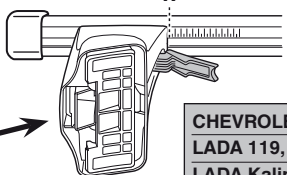
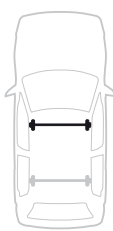

2

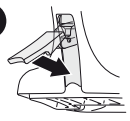

	X
CHEVROLET Niva, 5-dr SUV, 03-	38
LADA 119, 5-dr Hatchback, 05- (FIN)	24
LADA Kalina 1119, 5-dr Hatchback, 05-	24

1

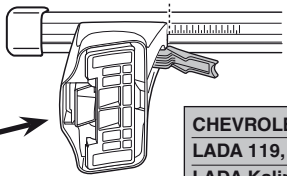

2



	Y
CHEVROLET Niva, 5-dr SUV, 03-	35,5
LADA 119, 5-dr Hatchback, 05- (FIN)	22,5
LADA Kalina 1119, 5-dr Hatchback, 05-	22,5



480R



480

1

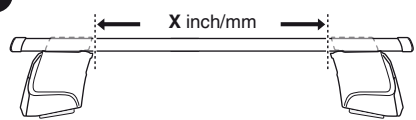
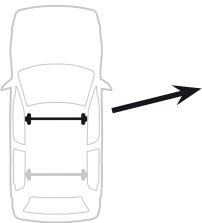

2



	X inch	X mm
CHEVROLET Niva, 5-dr SUV, 03-	40 ⁵/₈ "	1031 mm
LADA 119, 5-dr Hatchback, 05- (FIN)	35 ¹/₈ "	891 mm
LADA Kalina 1119, 5-dr Hatchback, 05-	35 ¹/₈ "	891 mm

1

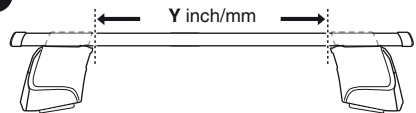
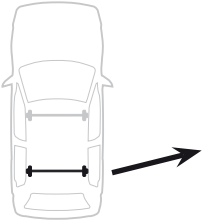

2



	Y inch	Y mm
CHEVROLET Niva, 5-dr SUV, 03-	39 ⁵/₈ "	1006 mm
LADA 119, 5-dr Hatchback, 05- (FIN)	34 ¹/₂ "	876 mm
LADA Kalina 1119, 5-dr Hatchback, 05-	34 ¹/₂ "	876 mm

4

CHEVROLET Niva, 5-dr SUV, 03–
LADA 119, 5-dr Hatchback, 05– (FIN)
LADA Kalina 1119, 5-dr Hatchback, 05–

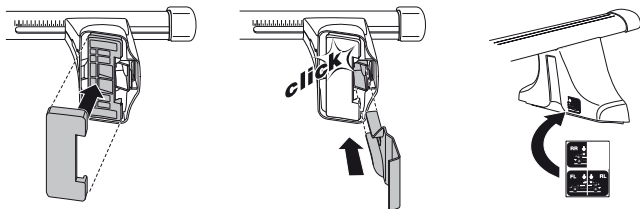
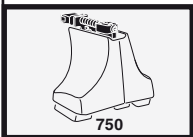
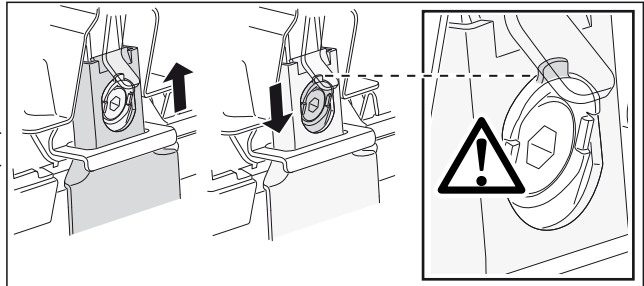
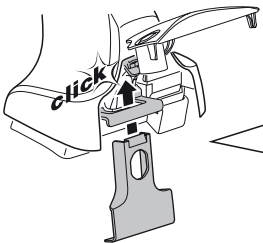
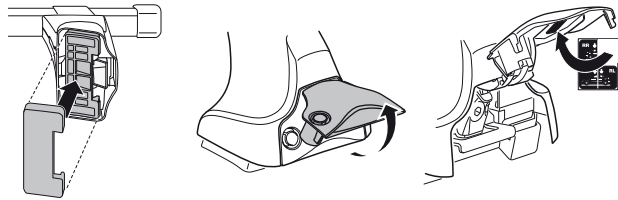
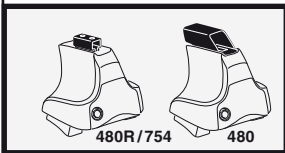
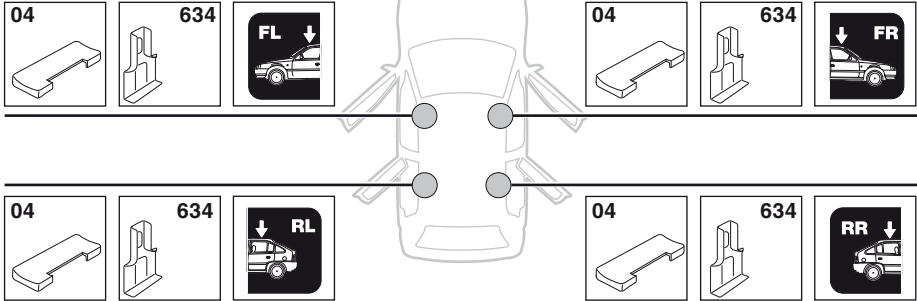

5

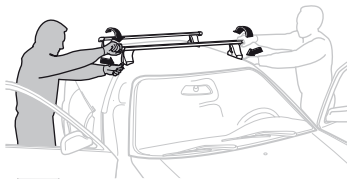
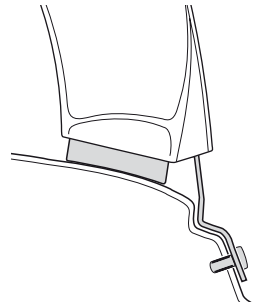
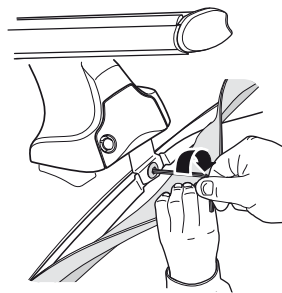
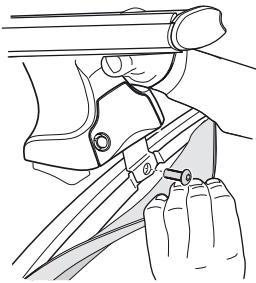
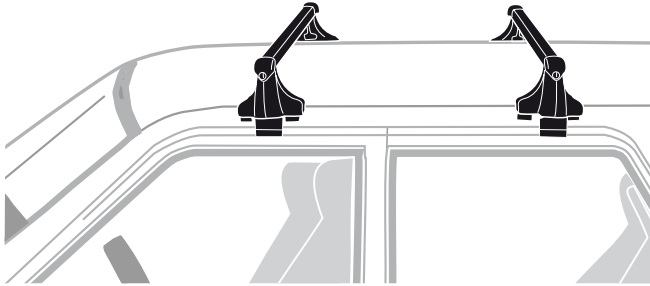
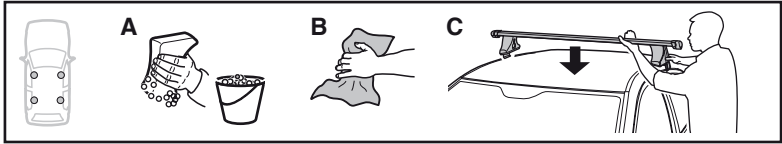

GB/US Tighten alternately

D Die Schrauben abwechselnd anziehen

F Serrer alternativement chaque côté

NL Afwisselend aan de linker- en de rechterkant aandraaien

I Alternare il serraggio delle viti

E Apretar alternativamente

PT Aperte alternadamente

S Dra åt växelvis

FIN Kierrä vuorotellen

EST Pinguldage vaheldumisi

LAT Pielieciet pamišus

LIT Užsukinėkite pakaitomis

PL Śruby dokręcaj naprzemiennie

RU Затягивайте попеременно

CZ Pokręťta багаžníka dokręcaj dokręcaj naprzemiennie.

SK Doťahujte striedavo

SLO Privijajte izmenično.

HR Naizmjenično zategnite

HU Egymástól függetlenül szorítandó

GR Σφίγγετε εναλλάξ

TR Dönüşümlü sıkın

中文 交替拧紧

한국어 번갈아 가며 조이십시오.

日本語 交互に締め付けてください。

ไทย ชั้้นในแบบสลับ

6



480R/754



480

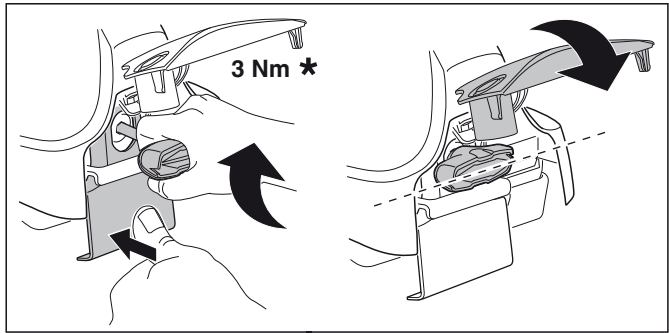
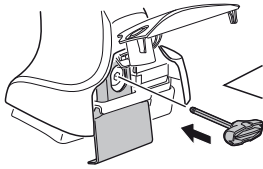

3 Nm *

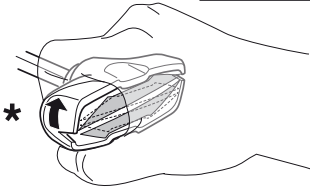

*

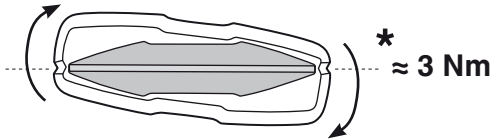

* ≈ 3 Nm



750

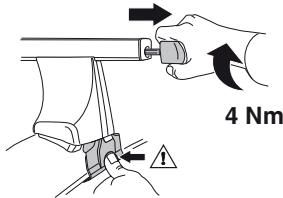

4 Nm

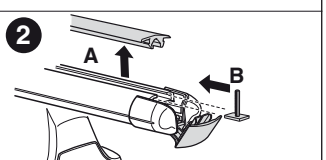
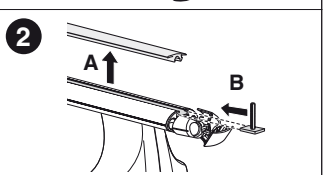
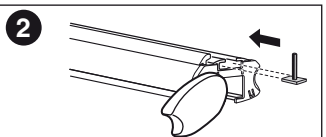
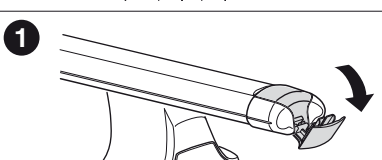
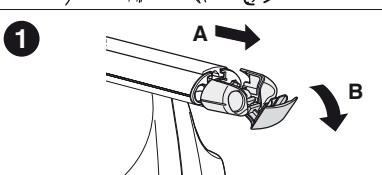
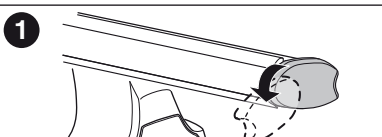
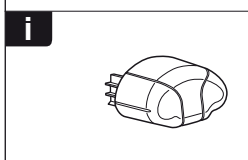
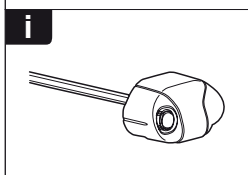
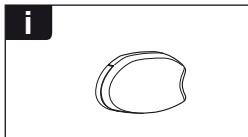
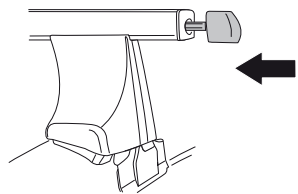

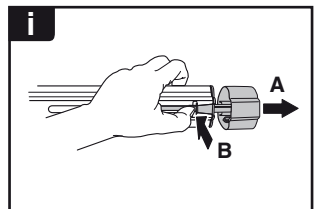
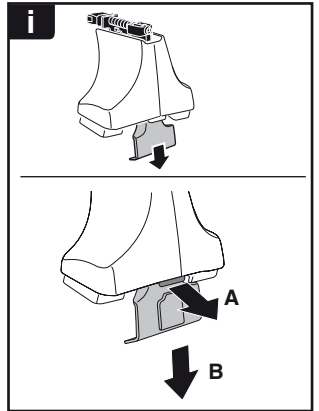
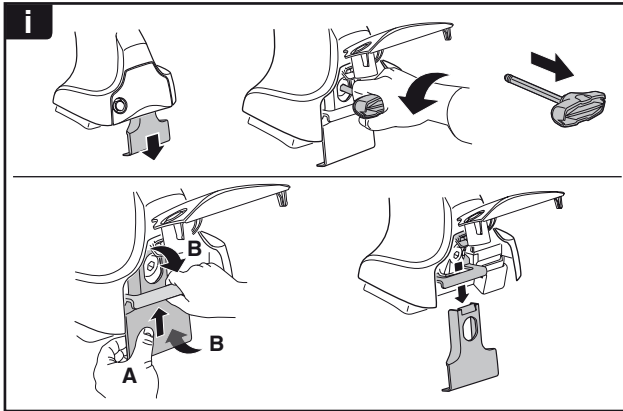
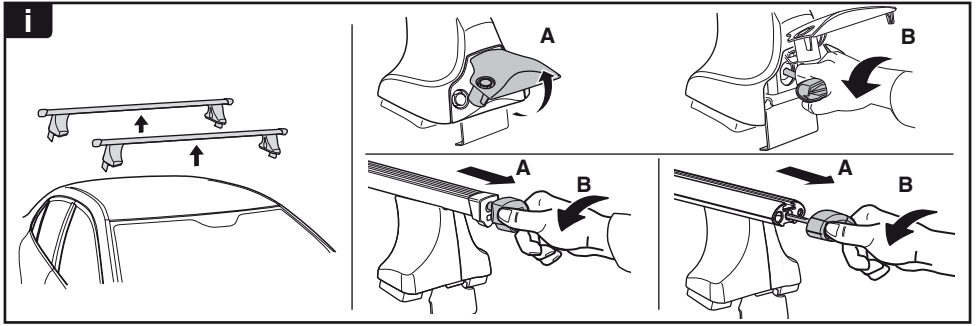

THULE
SWEDEN
**ONE
KEY
SYSTEM**



- 544 (x4)
- 596 (x6)
- 588 (x8)
- NA 510 (x10)
- EUR 452 (x12)
- ASIA

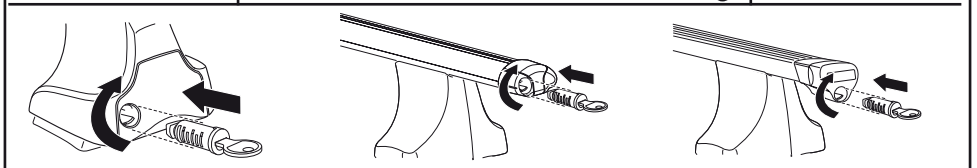

WW ▶ Thule Sweden AB, Box 69, 330 33 Hillerstorp, SWEDEN
NA ▶ Thule Inc., 42 Silvermine Road, Seymour, Connecticut 06483, USA

info@thule.com
customer.service@thule.com

www.thule.com