

Kit 1398

SEAT León, 5-dr Hatchback, 05-

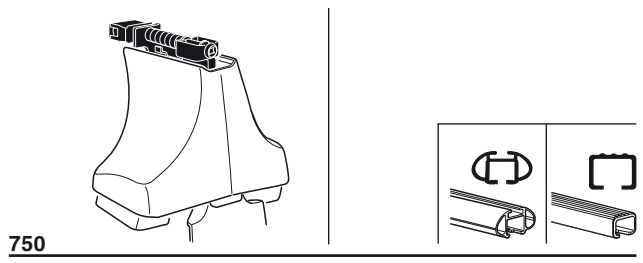

Kit

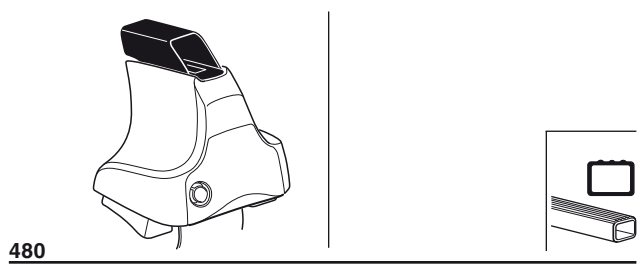
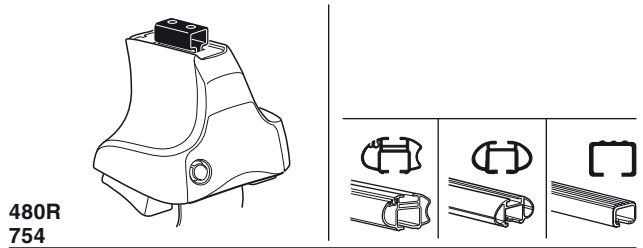

3



754

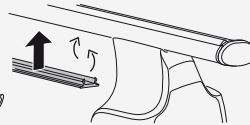
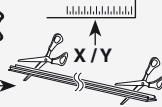

750



1

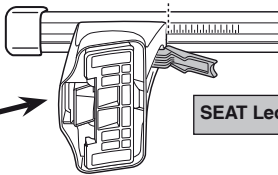
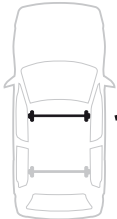

2

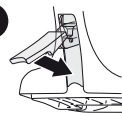

SEAT León, 5-dr Hatchback, 05-

X

37

1

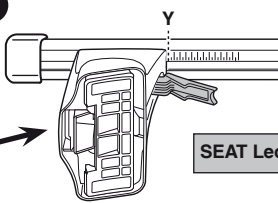
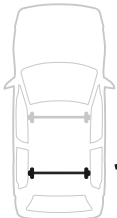

2

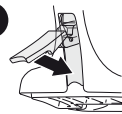

SEAT León, 5-dr Hatchback, 05-

Y

32



480R



480

1

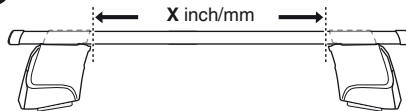

2

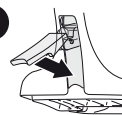

SEAT León, 5-dr Hatchback, 05-

X inch

X mm

40 1/4"

1021 mm

1

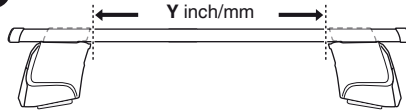

2

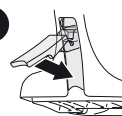

SEAT León, 5-dr Hatchback, 05-

Y inch

Y mm

38 1/4"

971 mm

4

SEAT León, 5-dr Hatchback, 05-

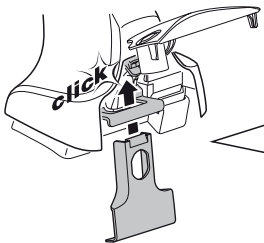
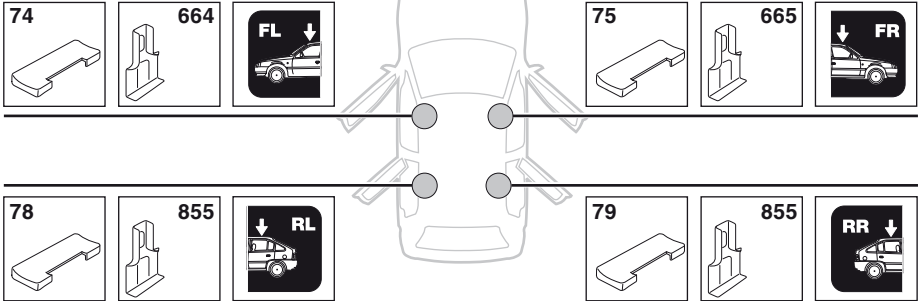

5



	X mm	Y mm	X inch	Y inch
SEAT León, 5-dr Hatchback, 05-	205 mm	710 mm	8 1/8"	28"

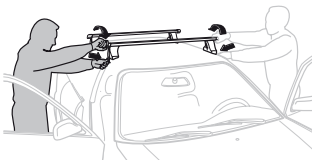
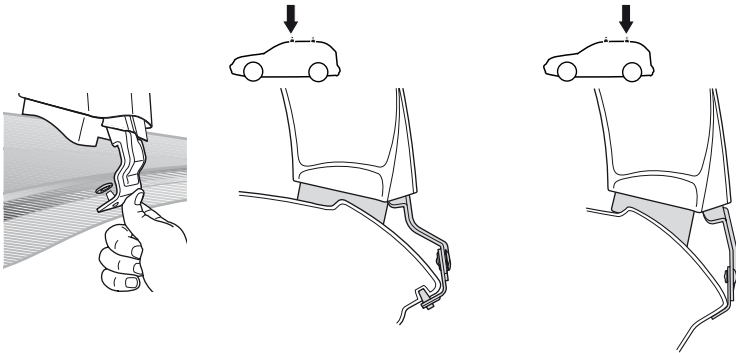
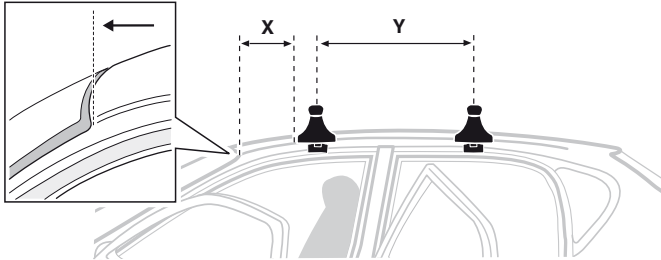

- | | | | |
|--------------|---|------------|---|
| GB/US | Tighten alternately | CZ | Pokręťta багаžníka dokřečaj dokřečaj naprzemiennie. |
| D | Die Schrauben abwechselnd anziehen | SK | Dotahujte striedavo |
| F | Serrer alternativement chaque côté | SLO | Privijajte izmenično. |
| NL | Afwisselend aan de linker- en de rechterkant aandraaien | HR | Naizmjenično zategnite |
| I | Alternare il serraggio delle viti | HU | Egymástól függetlenül szorítandó |
| E | Apretar alternativamente | GR | Σφιγγετε εναλλάξ |
| PT | Aperte alternadamente | TR | Dönüşümlü sıkın |
| S | Dra åt växelvis | 中文 | 交替拧紧 |
| FIN | Kierrä vuorotellen | 한국어 | 변갈아 가며 조이십시오. |
| EST | Pinguldage vaheldumisi | 日本語 | 交互に締め付けてください。 |
| LAT | Pielieciet pamišus | ไทย | ขันในแบบสลับ |
| LIT | Užsukinkite pakaitomis | | |
| PL | Śruby dokřečaj naprzemiennie | | |
| RU | Затягивайте попеременно | | |

6



480R/754



480

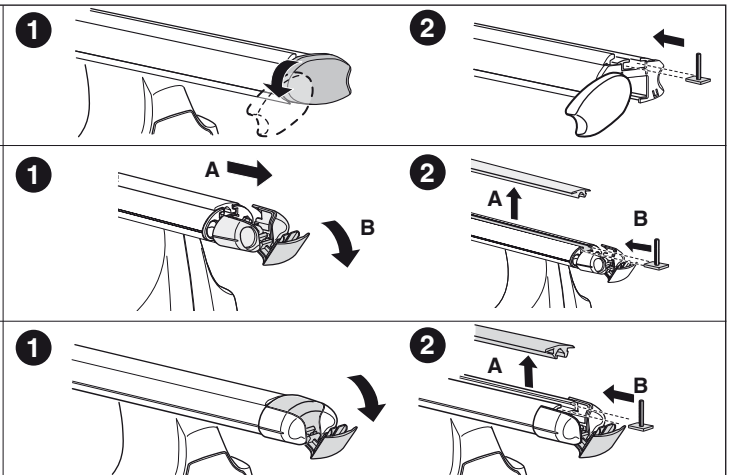
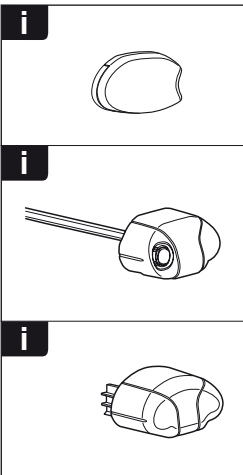
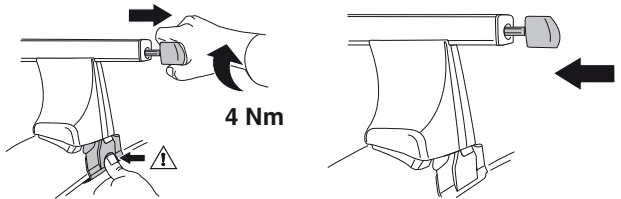
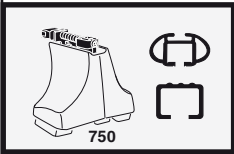



THULE
SWEDEN
**ONE
KEY
SYSTEM**



- 544 (x4)
- 596 (x6)
- 588 (x8)
- NA 510 (x10)
- EUR 452 (x12)
- ASIA



WW ▶ Thule Sweden AB, Box 69, 330 33 Hillerstorp, SWEDEN
NA ▶ Thule Inc., 42 Silvermine Road, Seymour, Connecticut 06483, USA

info@thule.com
customer.service@thule.com

www.thule.com