

Kit 1514

HYUNDAI i20, 3-dr Hatchback, 09–
HYUNDAI i20, 5-dr Hatchback, 09–

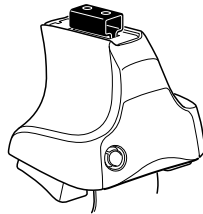

754 Rapid System
480R Rapid Traverse (North America)

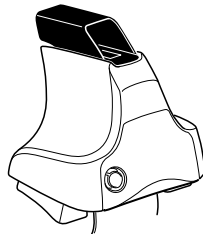
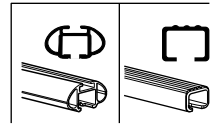

480 Traverse (North America)

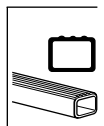

3-dr Max. 50 kg/110 lbs

5-dr Max. 60 kg/132 lbs

xx kg
xx lbs

7 kg / 15,4 lbs

3 kg / 6,6 lbs

80 km/h / 50 Mph
130 km/h / 80 Mph
40 km/h / 25 Mph

km/h
Mph

THULE

Kit XXXX

instructions

754 Rapid System x4

480R Rapid Traverse (North America) x4

x1

x4

x4

754 Rapid System

480R Rapid Traverse (North America)

x1

x4

x4

480 Traverse (North America)

(North America)

x2

x2

23 mm

x1

17 mm

x2

23 mm

x2

x4

x4

x2

x2

x2

x2

x2

x2

x1

318 x2

475 x2

65 x2

120 x1

121 x1

x1

RR ↓ FR
FL ↓ RL

1

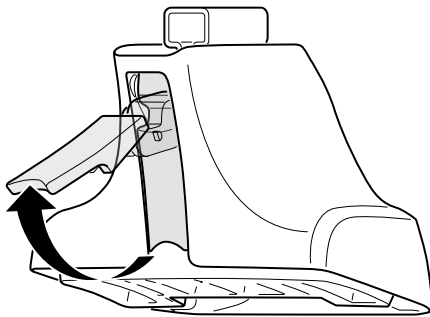

2



754 Rapid System
480R Rapid Traverse
(North America)

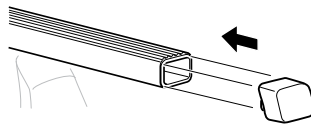
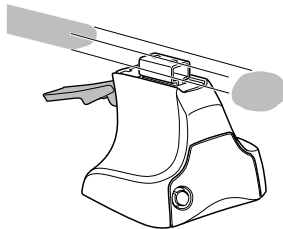

x4

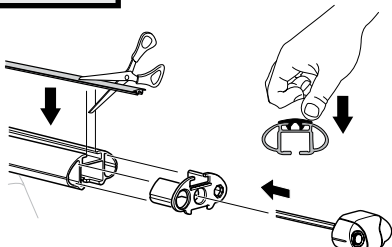
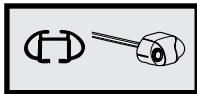

x4

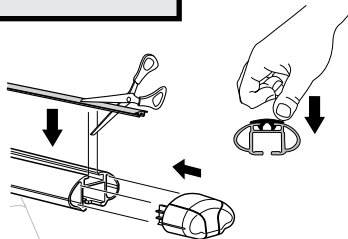
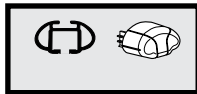

x4

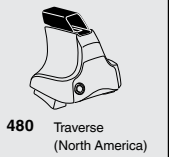

480 Traverse
(North America)

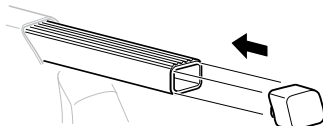
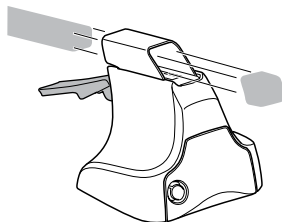

x4

3

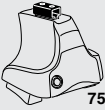

754 Rapid System

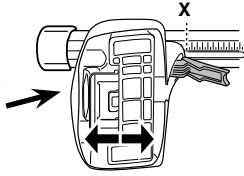

X

	X
HYUNDAI i20, 3-dr Hatchback, 09–	33
HYUNDAI i20, 5-dr Hatchback, 09–	33

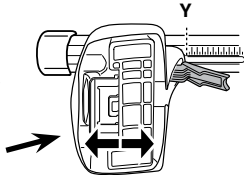

Y

	Y
HYUNDAI i20, 3-dr Hatchback, 09–	29
HYUNDAI i20, 5-dr Hatchback, 09–	29

3



480R Rapid Traverse



480 Traverse

(North America)

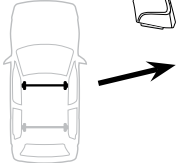

	X inch	X mm
HYUNDAI i20, 3-dr Hatchback, 09–	38 ⁵/₈ "	981 mm
HYUNDAI i20, 5-dr Hatchback, 09–	38 ⁵/₈ "	981 mm

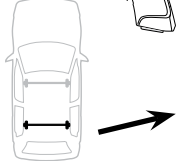

	Y inch	Y mm
HYUNDAI i20, 3-dr Hatchback, 09–	37 "	941 mm
HYUNDAI i20, 5-dr Hatchback, 09–	37 "	941 mm

4

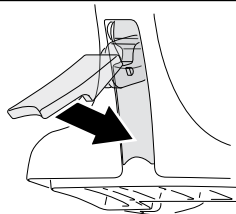

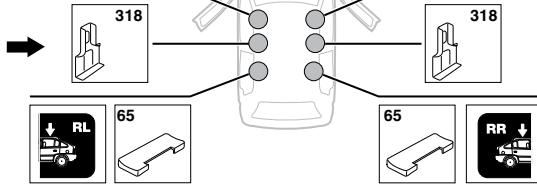
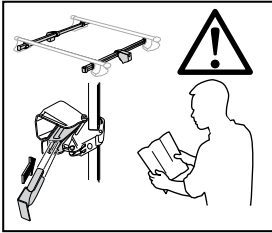
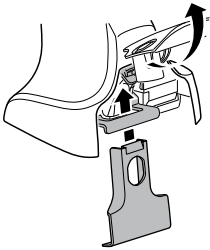
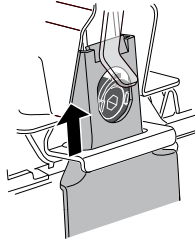
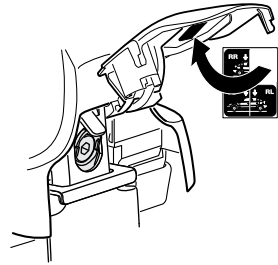
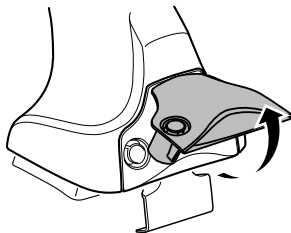
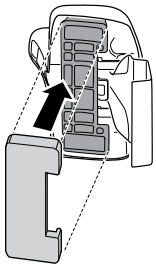
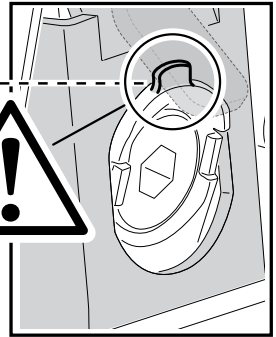
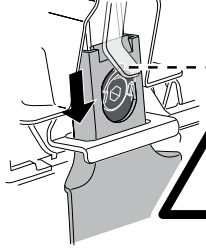
5**HYUNDAI i20, 3-dr Hatchback, 09–****SRA****HYUNDAI i20, 5-dr Hatchback, 09–****A****B****C**

6

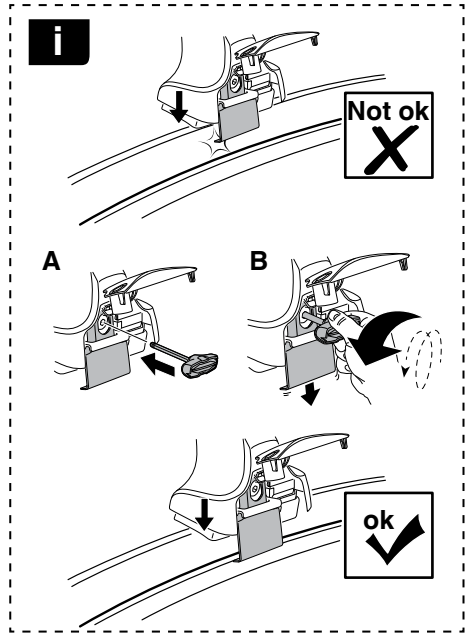
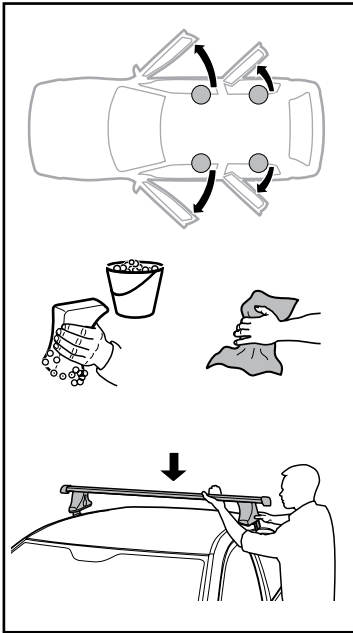

	X mm	Y mm	X inch	Y inch
HYUNDAI i20, 3-dr Hatchback, 09-	190 mm	670 mm	7 1/2"	26 3/8"
HYUNDAI i20, 5-dr Hatchback, 09-	190 mm	700 mm	7 1/2"	27 1/2"

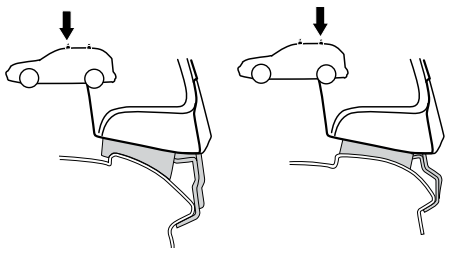
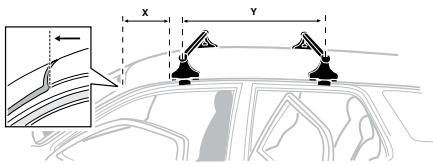

HYUNDAI i20, 3-dr Hatchback, 09-

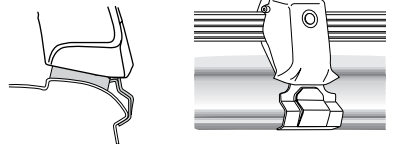
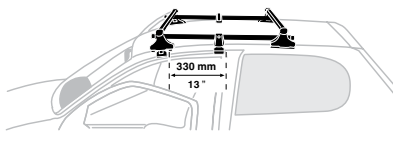

7

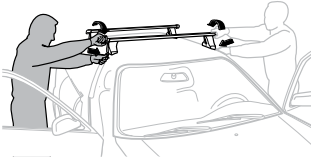

GB/US Tighten alternately
D Die Schrauben abwechselnd anziehen
F Serrer alternativement chaque côté
NL Afwisselend aan de linker- en de rechterkant aandraaien
I Alternare il serraggio delle viti
E Apretar alternativamente
PT Aperte alternadamente
S Dra åt växelvis
FIN Kierrä vuorotellen
EST Pinguldage vaheldumisi
LAT Pievelciēt pamišus
LIT Užsukinėkite pakaitomis
PL Śruby dokręcaj naprzemiennie
RU Затягивайте попеременно

CZ Pokrétla bagażnika dokręcaj dokręcaj naprzemiennie.
SK Doťahujte striedavo
SLO Privijajte izmenično.
HR Naizmjenično zategnite
HU Egymástól függetlenül szorítandó
GR Σφιγγετέ εναλλάξ
TR Dönüşümlü sıkın

中文 交替拧紧

한국어 번갈아 가며 조이십시오.

日本語 交互に締め付けてください。

ไทย ช้อนในแบบสลับ

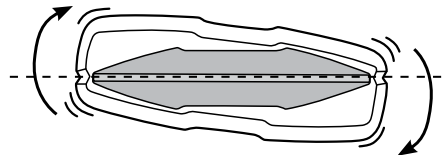
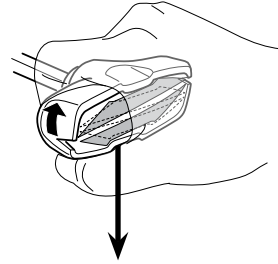
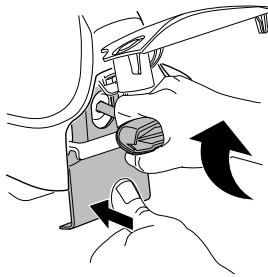
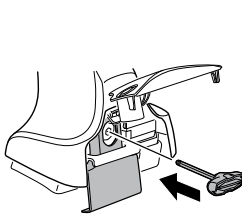

≈ 3 Nm

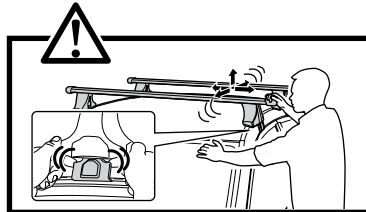
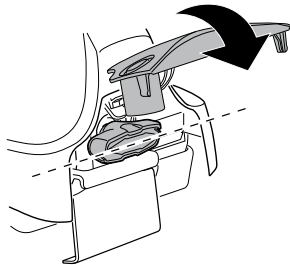

8



x1
17 mm

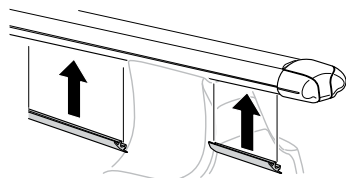

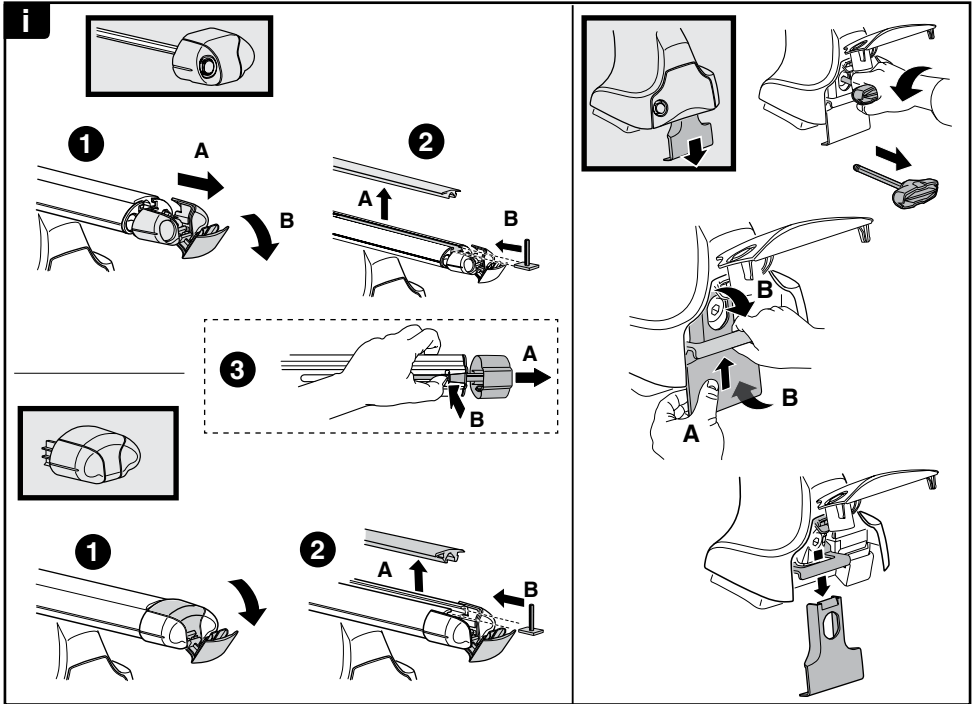

THULE
SWEDEN
**ONE
KEY
SYSTEM**

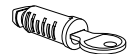
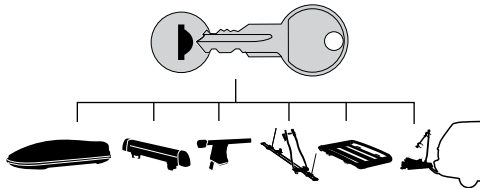

544 (x4)

596 (x6)

588 (x8)

NA **510** (x10)

EUR **452** (x12)

ASIA

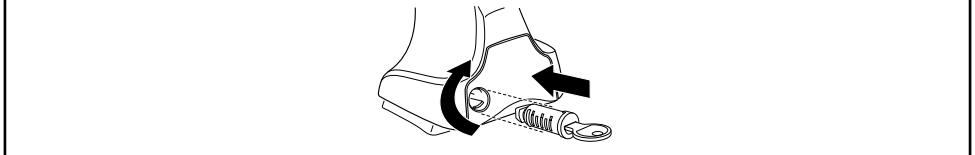

WW ▶ Thule Sweden AB, Box 69, 330 33 Hillerstorp, SWEDEN
NA ▶ Thule Inc., 42 Silvermine Road, Seymour, Connecticut 06483, USA

info@thule.com
customer.service@thule.com

www.thule.com

503-1514-03