

# Kit 1520

DODGE Ram 1500, 2-dr Single Cab, 09–  
DODGE Ram 1500, 4-dr Crew Cab, 09–  
DODGE Ram 1500, 4-dr Double Cab, 09–

480R  
754

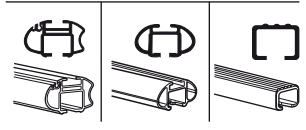
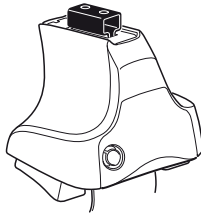

480

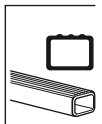
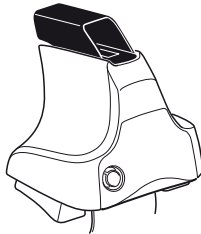

750

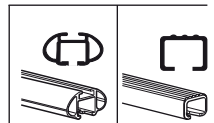
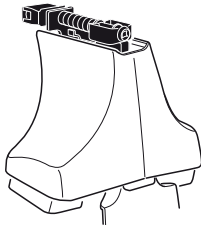

xx kg  
 xx lbs + 7 kg  
 15,4 lbs = **Max. 40kg**  
**Max. 88 lbs**

80 km/h 130 km/h  
 50 Mph 80 Mph  
 40 km/h 25 Mph  
 km/h Mph

**THULE** **Kit XXXX**

instructions

x4  
 x4  
**480R/754**

x4  
 x4  
**480**

x4  
 x4  
**750**

x2	x2	x2	x2	x2
x2	x2	x2	x2	x2
x2	x2	x4	x4	x4
x4		x4		

**192** x 4      **45** x 4

**RR** **FR**  
**PL** **RL**

**Kit** x 1



**3**



754

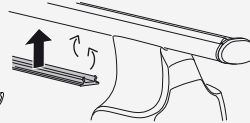
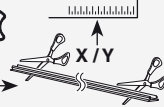

750



**1**

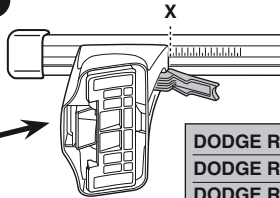
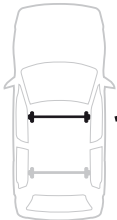

**2**

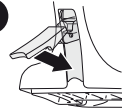

	X	
DODGE Ram 1500, 2-dr Single Cab, 09-	64,5	
DODGE Ram 1500, 4-dr Crew Cab, 09-	64,5	
DODGE Ram 1500, 4-dr Double Cab, 09-	64,5	

**1**

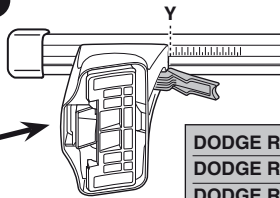

**2**

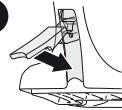

	Y	
DODGE Ram 1500, 2-dr Single Cab, 09-	64,5	
DODGE Ram 1500, 4-dr Crew Cab, 09-	63,5	
DODGE Ram 1500, 4-dr Double Cab, 09-	63,5	



480R



480

**1**

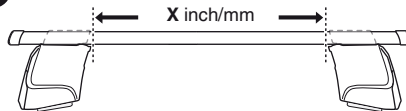

**2**



	X inch	X mm
DODGE Ram 1500, 2-dr Single Cab, 09-	51 "	1295 mm
DODGE Ram 1500, 4-dr Crew Cab, 09-	51 "	1295 mm
DODGE Ram 1500, 4-dr Double Cab, 09-	51 "	1295 mm

**1**

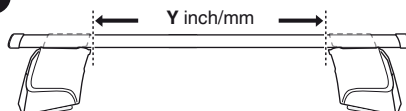

**2**



	Y inch	Y mm
DODGE Ram 1500, 2-dr Single Cab, 09-	51 "	1295 mm
DODGE Ram 1500, 4-dr Crew Cab, 09-	50 <sup>5</sup> / <sub>8</sub> "	1285 mm
DODGE Ram 1500, 4-dr Double Cab, 09-	50 <sup>5</sup> / <sub>8</sub> "	1285 mm

# 4

**DODGE Ram 1500, 2-dr Single Cab, 09–**  
**DODGE Ram 1500, 2-dr 4-dr Crew Cab, 09–**  
**DODGE Ram 1500, 4-dr Double Cab, 09–**

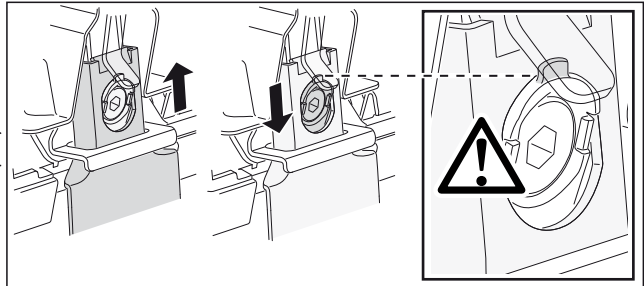
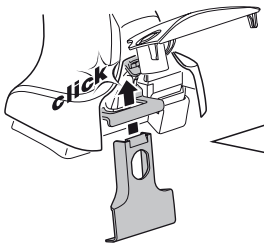
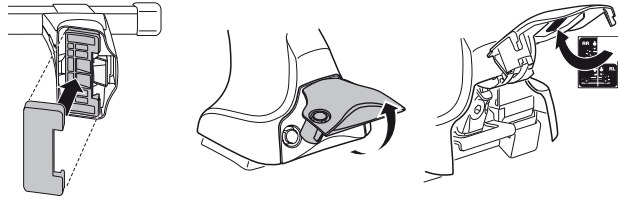
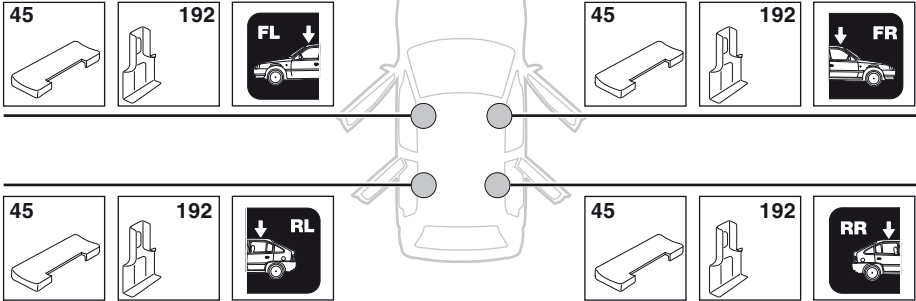

5



	X mm	Y mm	X inch	Y inch
<b>DODGE Ram 1500, 2-dr Single Cab, 09–</b>	110 mm	350 mm	4 1/4"	13 3/4"
<b>DODGE Ram 1500, 4-dr Crew Cab, 09–</b>	110 mm	800 mm	4 1/4"	31 1/2"
<b>DODGE Ram 1500, 4-dr Double Cab, 09–</b>	110 mm	800 mm	4 1/4"	31 1/2"

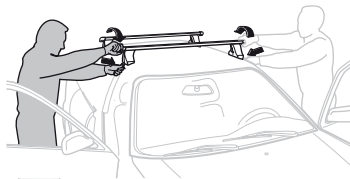
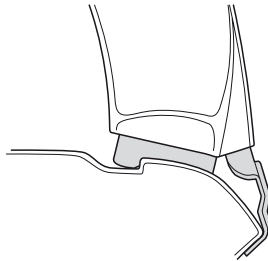
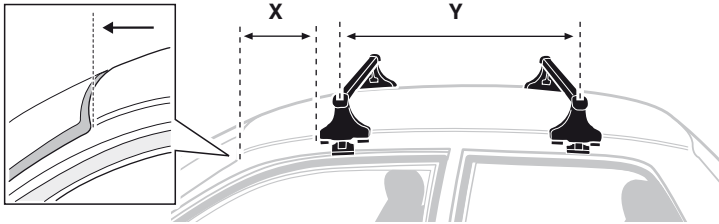

**GB/US** Tighten alternately

**D** Die Schrauben abwechselnd anziehen

**F** Serrer alternativement chaque côté

**NL** Afwisselend aan de linker- en de rechterkant aandraaien

**I** Alternare il serraggio delle viti

**E** Serrare alternativamente

**PT** Aperte alternadamente

**S** Dra åt växelvis

**FIN** Kierrä vuorotellen

**EST** Pinguldage vaheldumisi

**LAT** Pielieciet pamīšus

**LIT** Užsukinėkite pakaitomis

**PL** Śruby dokręcaj naprzemiennie

**RU** Затягивайте попеременно

**CZ** Pokręťta bagażníka dokręcaj dokręcaj naprzemiennie.

**SK** Doťahujte striedavo

**SLO** Privijajte izmenično.

**HR** Naizmjenično zategnite

**HU** Egymástól függetlenül szorítandó

**GR** Σφίγγετε εναλλάξ

**TR** Dönüşümlü sıkın

**中文** 交替拧紧

**한국어** 번갈아 가며 조이십시오.

**日本語** 交互に締め付けてください。

**ไทย** ชั้้นโน้บแบบสลับ

6



480R/754



480

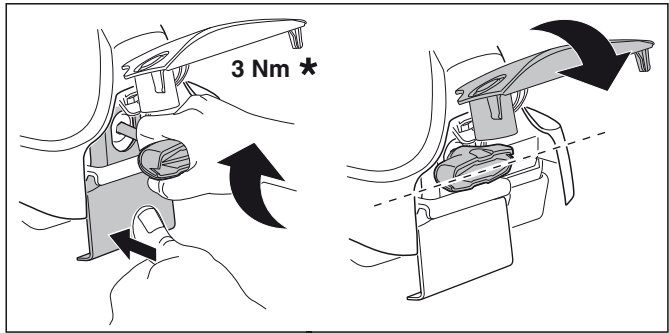
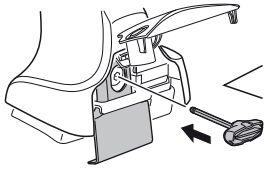

3 Nm \*

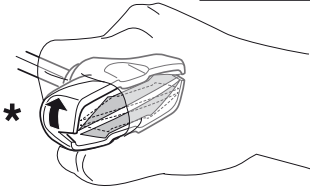

\*

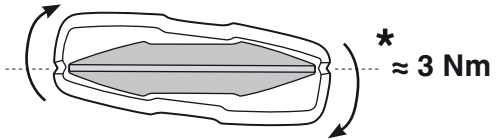

\* ≈ 3 Nm



750

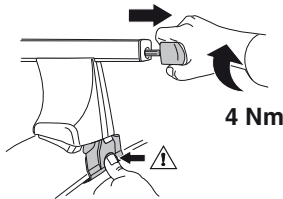

4 Nm

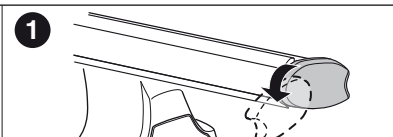
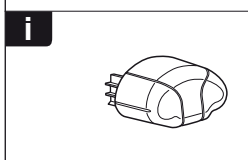
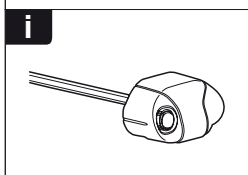
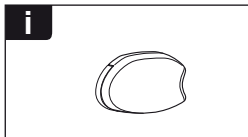
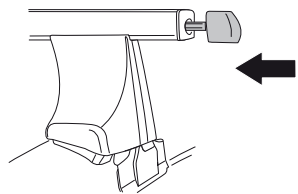

1

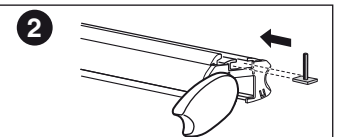

2

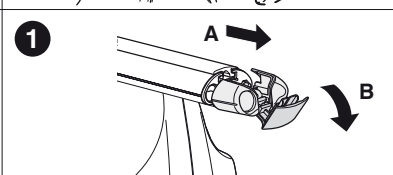

1

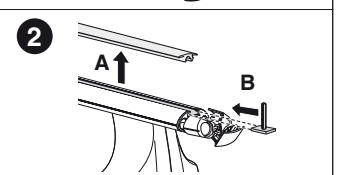

2

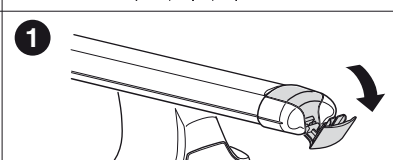

1

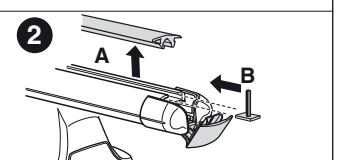

2



**THULE**  
SWEDEN  
**ONE  
KEY  
SYSTEM**



- 544** (x4)
- 596** (x6)
- 588** (x8)
- NA **510** (x10)
- EUR **452** (x12)
- ASIA



WW ▶ Thule Sweden AB, Box 69, 330 33 Hillerstorp, SWEDEN  
NA ▶ Thule Inc., 42 Silvermine Road, Seymour, Connecticut 06483, USA

info@thule.com  
customer.service@thule.com

www.thule.com