

Kit 1543

RENAULT Scénic III, 5-dr MPV, 09–

RENAULT Grand Scénic III, 5-dr MPV, 09–

480R
754

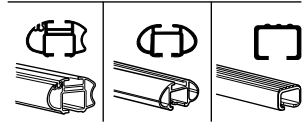
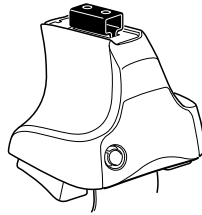

480

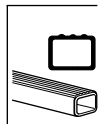
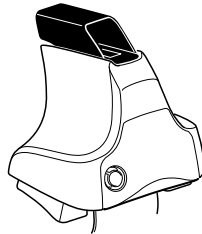

750

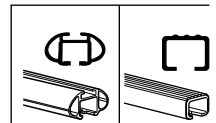
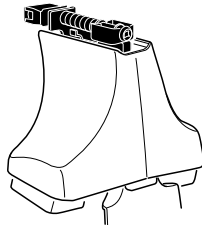

THULE[®]
SWEDEN

x2 x2 x2 x4	x2	x2 x2 x4 x4	x2 x2	x2

1053 x 4

179 x 2

181 x 2

x 1

Kit



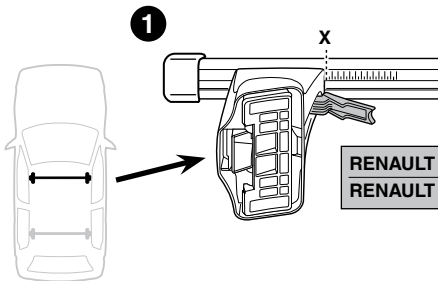
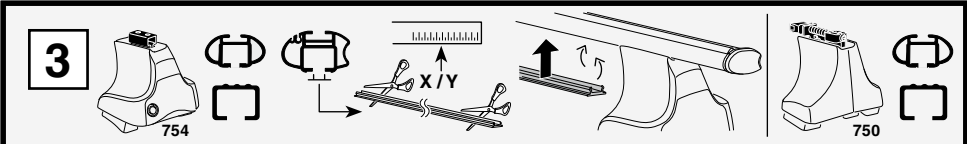

	X
RENAULT Scénic III, 5-dr MPV, 09–	41,5
RENAULT Grand Scénic III, 5-dr MPV, 09–	41,5

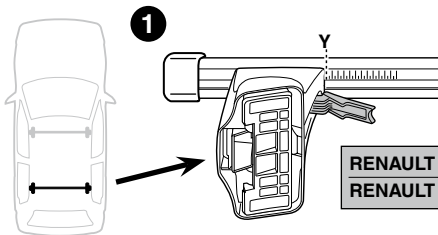

	Y
RENAULT Scénic III, 5-dr MPV, 09–	40,5
RENAULT Grand Scénic III, 5-dr MPV, 09–	40,5

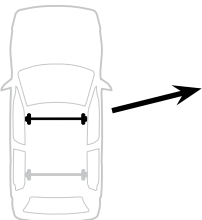
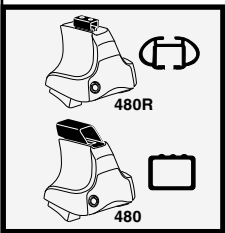

	X inch	X mm
RENAULT Scénic III, 5-dr MPV, 09–	42"	1066 mm
RENAULT Grand Scénic III, 5-dr MPV, 09–	42"	1066 mm

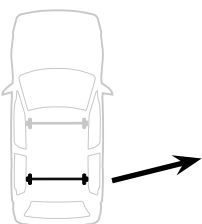

	Y inch	Y mm
RENAULT Scénic III, 5-dr MPV, 09–	41 ⁵ / ₈ "	1056 mm
RENAULT Grand Scénic III, 5-dr MPV, 09–	41 ⁵ / ₈ "	1056 mm

4

RENAULT Scénic III, 5-dr MPV, 09–
RENAULT Grand Scénic III, 5-dr MPV, 09–

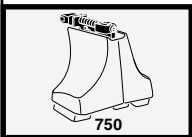
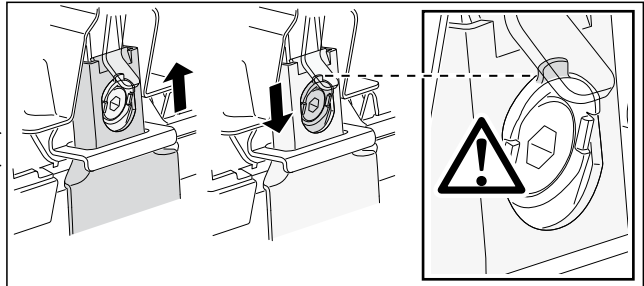
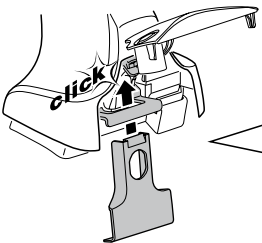
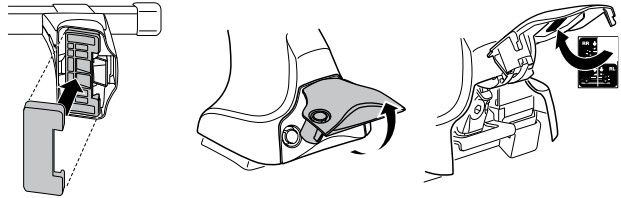
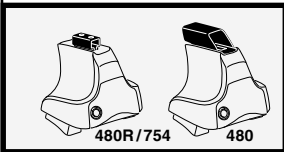
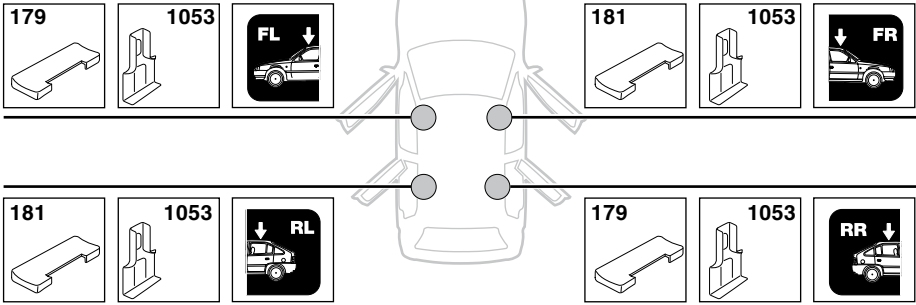

5



	X mm	Y mm	X inch	Y inch
RENAULT Scénic III, 5-dr MPV, 09-	265mm	730 mm	10 ³ / ₈ "	28 ³ / ₄ "
RENAULT Grand Scénic III, 5-dr MPV, 09-	265mm	730 mm	10 ³ / ₈ "	28 ³ / ₄ "

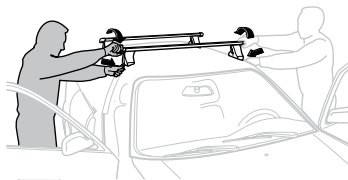
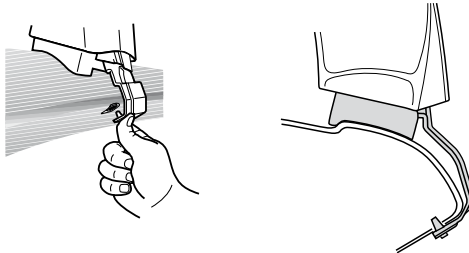
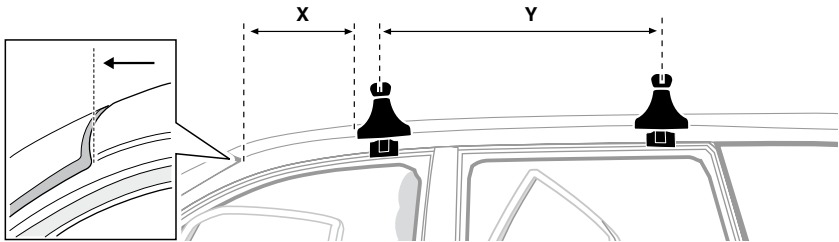

GB/US Tighten alternately

D Die Schrauben abwechselnd anziehen

F Serrer alternativement chaque côté

NL Afwisselend aan de linker- en de rechterkant aandraaien

I Alternare il serraggio delle viti

E Apretar alternativamente

PT Aperte alternadamente

S Dra åt växelvis

FIN Kierrä vuorotellen

EST Pinguldage vaheldumisi

LAT Pielieciet pamišus

LIT Užsukinėkite pakaitomis

PL Śruby dokręcaj naprzemiennie

RU Затягивайте попеременно

CZ Pokręťta bagażníka dokręcaj dokręcaj naprzemiennie.

SK Doťahujte striedavo

SLO Privijajte izmenično.

HR Naizmjenično zategnite

HU Egymástól függetlenül szorítandó

GR Σφίγγετε εναλλάξ

TR Dönüşümlü sıkın

中文 交替拧紧

한국어 번갈아 가며 조이십시오.

日本語 交互に締め付けてください。

ไทย ชั้ไนแบบสลับ

6



480R/754



480

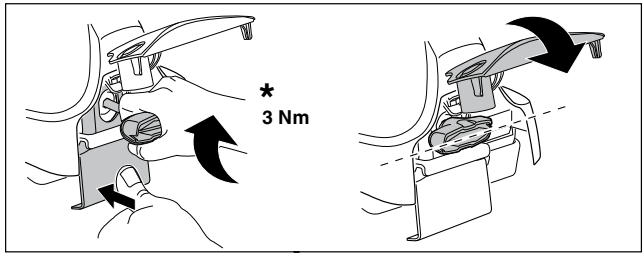

*
3 Nm



*



*
≈ 3 Nm

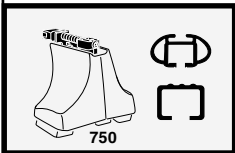

750

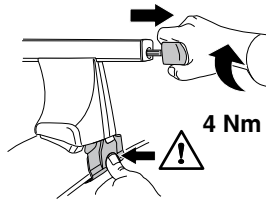

4 Nm

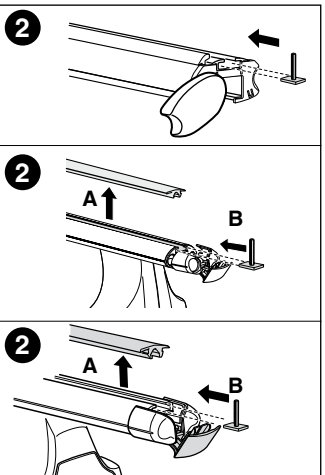
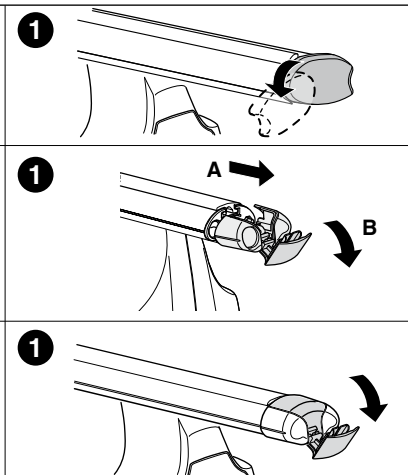
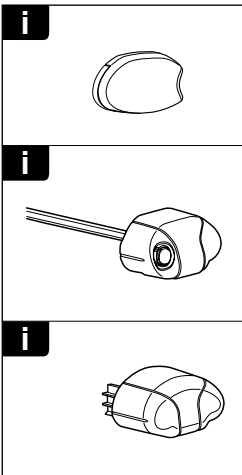
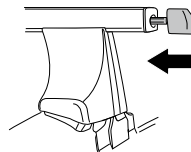



THULE
SWEDEN
**ONE
KEY
SYSTEM**



		(x4)
		(x6)
		(x8)
NA		(x10)
EUR		(x12)
ASIA		(x12)



WW ▶ Thule Sweden AB, Box 69, 330 33 Hillerstorp, SWEDEN
NA ▶ Thule Inc., 42 Silvermine Road, Seymour, Connecticut 06483, USA

info@thule.com
customer.service@thule.com

www.thule.com