

Kit 1564

VOLKSWAGEN Polo (Mk.V), 5-dr Hatchback, 09–

480R
754

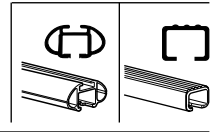
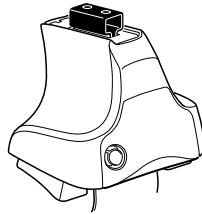

480

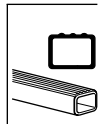
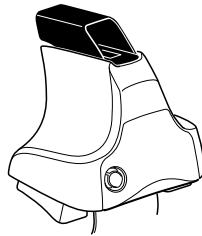

750

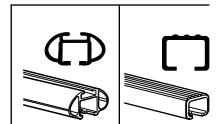
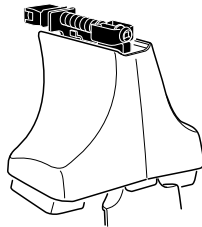

Kit

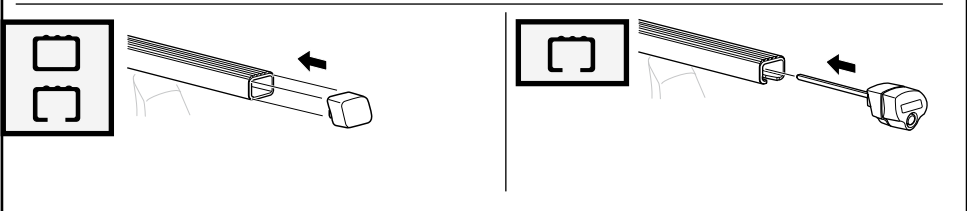
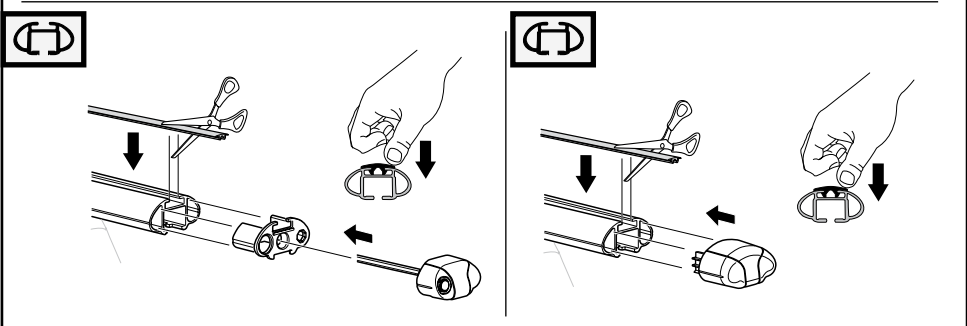
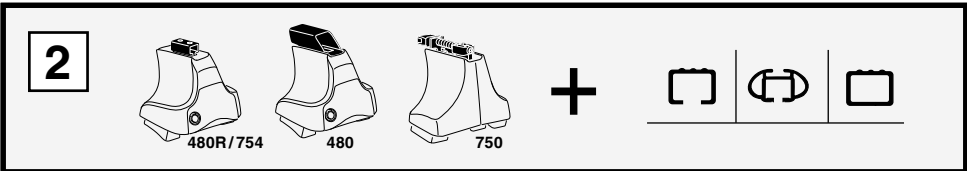

3

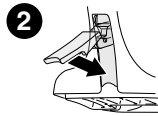
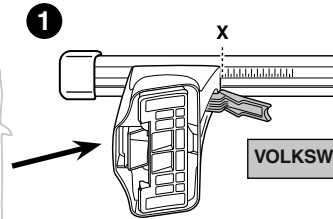
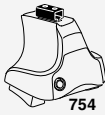

	X
VOLKSWAGEN Polo (Mk.V), 5-dr Hatchback, 09-	37

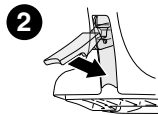
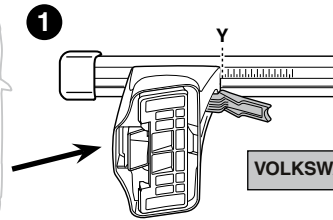

	Y
VOLKSWAGEN Polo (Mk.V), 5-dr Hatchback, 09-	33



480R



480

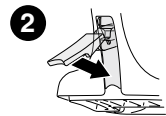
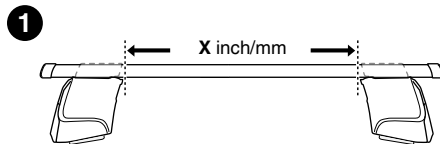

	X inch	X mm
VOLKSWAGEN Polo (Mk.V), 5-dr Hatchback, 09-	40 1/4"	1021 mm

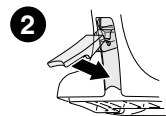
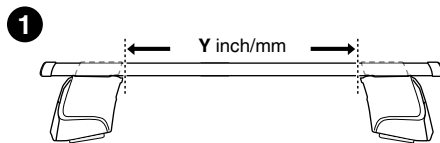

	Y inch	Y mm
VOLKSWAGEN Polo (Mk.V), 5-dr Hatchback, 09-	38 5/8"	981 mm

4

VOLKSWAGEN Polo (Mk.V), 5-dr Hatchback, 09-

331



1056



FL



332



1056



FR



328



1048



RL



328



1048



RR

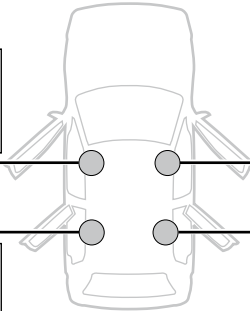

480R/754



480

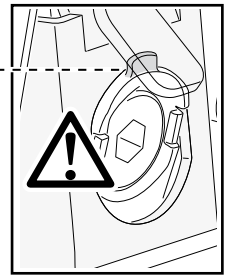
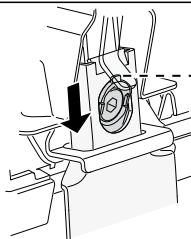
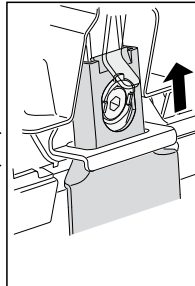
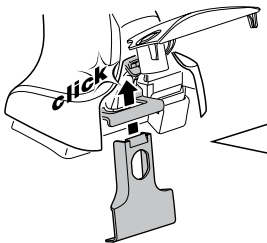
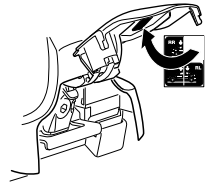
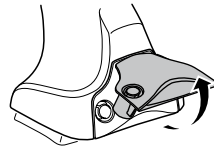
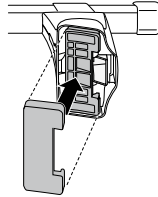

750

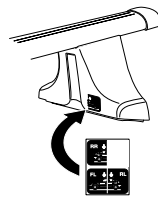
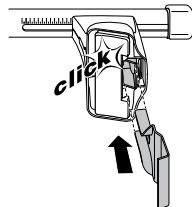
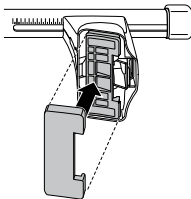

5

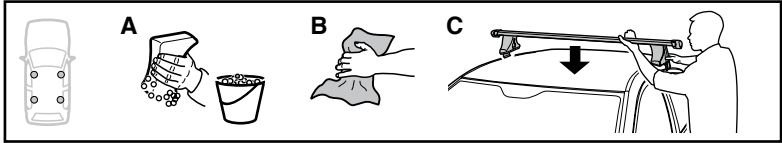

	X mm	Y mm	X inch	Y inch
VOLKSWAGEN Polo (Mk.V), 5-dr Hatchback, 09-	180 mm	800 mm	7 1/8"	31 1/2"

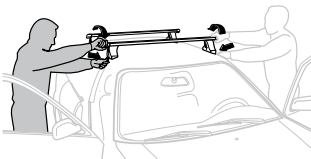
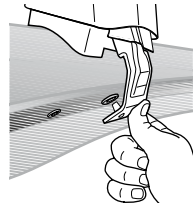
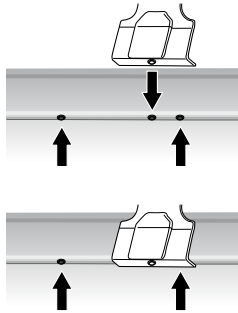
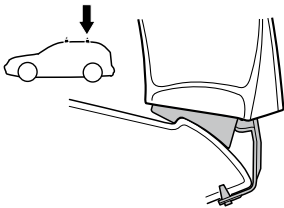
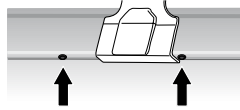
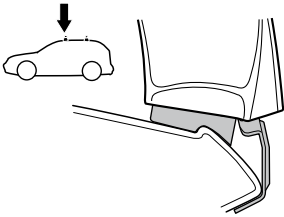
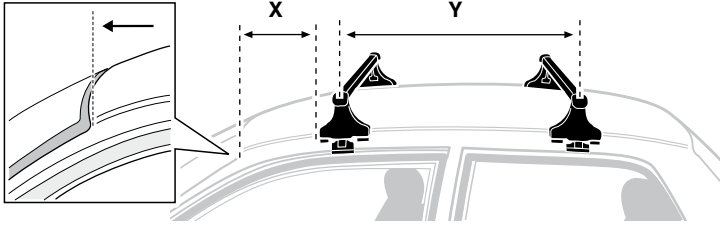

- GB/US** Tighten alternately
D Die Schrauben abwechselnd anziehen
F Serrer alternativement chaque côté
NL Afwisselend aan de linker- en de rechterkant aandraaien
I Alternare il serraggio delle viti
E Apretar alternativamente
PT Aperte alternadamente
S Dra åt växelvis
FIN Kierrä vuorotellen
EST Pinguldage vaheldumisi
LAT Pieļieciet pamišus
LIT Užsukinkite pakaitomis
PL Śruby dokręcaj naprzemiennie
RU Затягивайте попеременно

- CZ** Pokręťta багажника dokręcaj dokręcaj naprzemiennie.
SK Dofahujte striedavo
SLO Privijajte izmenično.
HR Naizmjениčno zategnite
HU Egymástól függetlenül szorítandó
GR Σφιγίγες ενολάξ
TR Dönüşümlü sıkın

中文 交替拧紧

한국어 번갈아 가며 조이십시오.

日本語 交互に締め付けてください。

ไทย ชั้้นโน้บแบบสลับ

6



480R/754



480

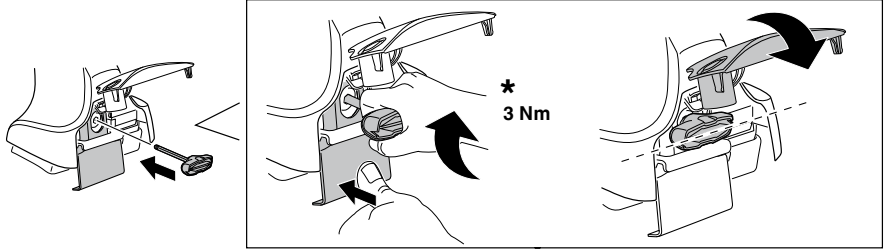

*
3 Nm

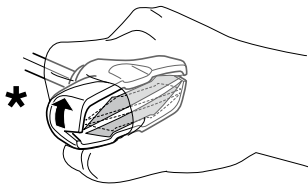

*

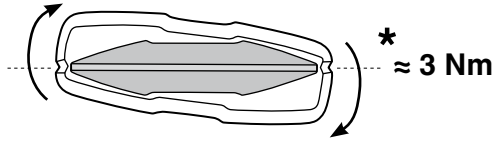

*
≈ 3 Nm

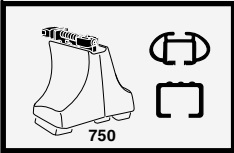
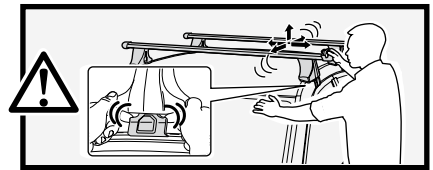

750

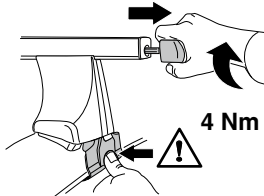

4 Nm

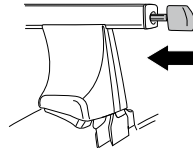

7



x1
17 mm

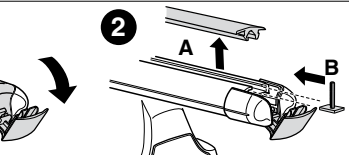
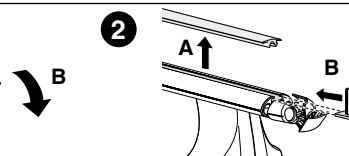
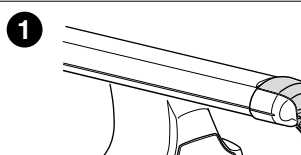
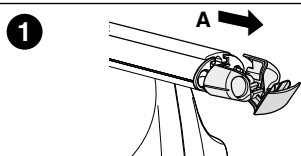
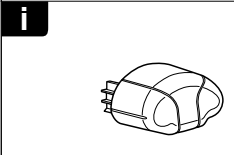
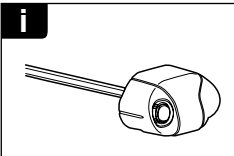
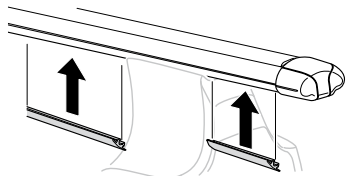



THULE
SWEDEN
**ONE
KEY
SYSTEM**

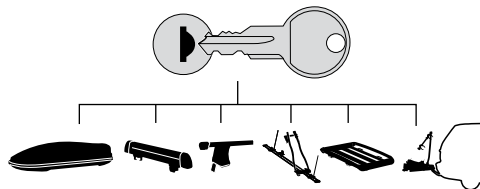

- 544 (x4)
- 596 (x6)
- 588 (x8)
- NA 510 (x10)
- EUR 452 (x12)
- ASIA

