

# Kit 1572

VW Transporter T4, 4-dr Van, 91-96, 97-02

VW Eurovan, 4-dr Van, \*92-03

\*North America

480R  
754

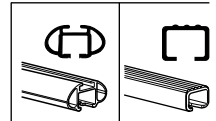
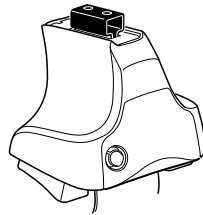

480

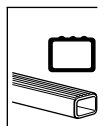
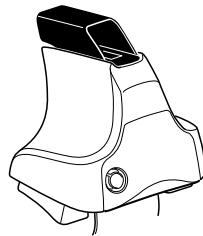

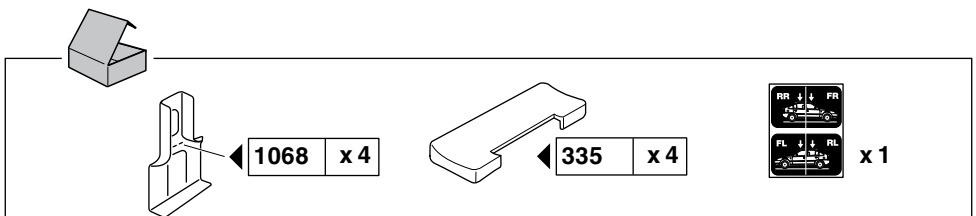
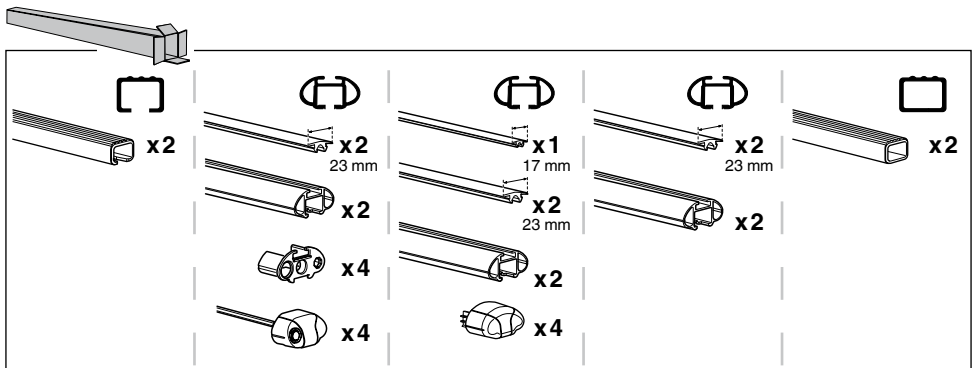
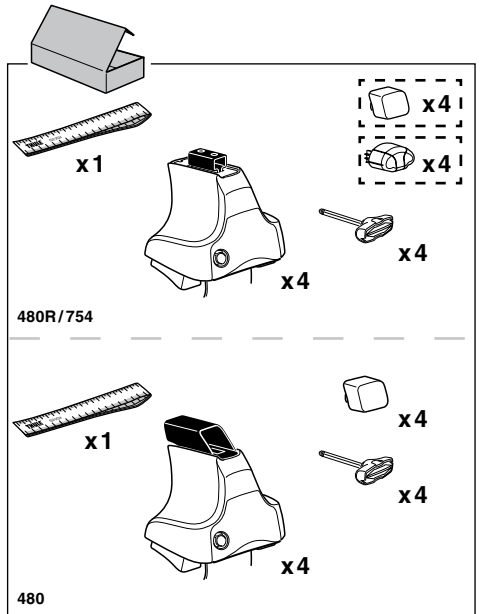
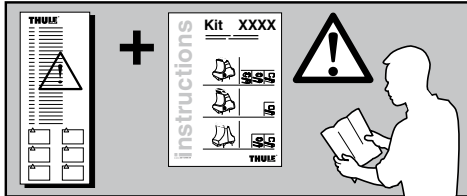
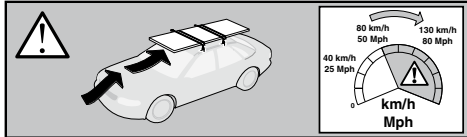
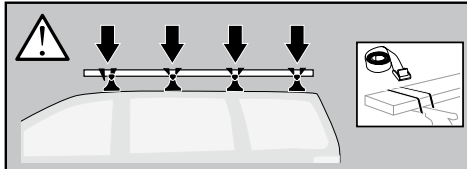

**Kit**

1

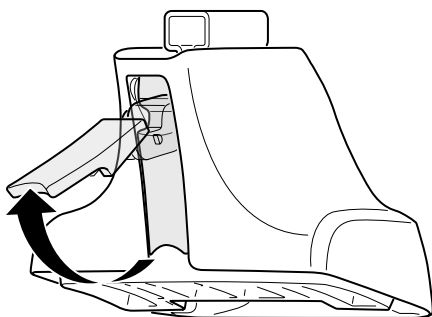
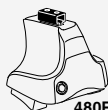

2

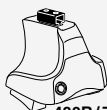

+

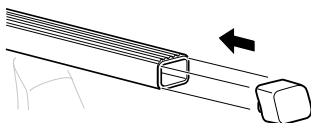
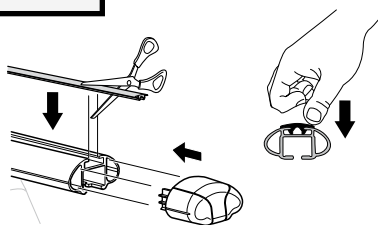
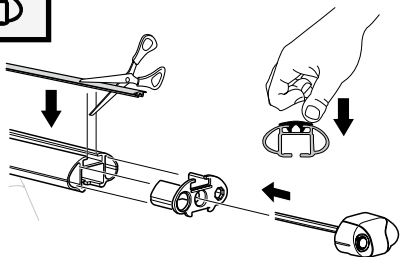
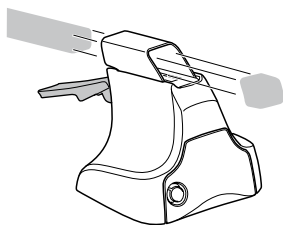
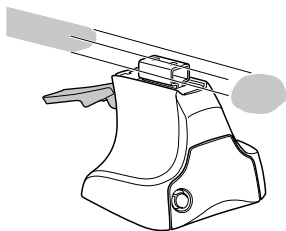

3

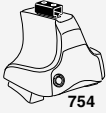

754

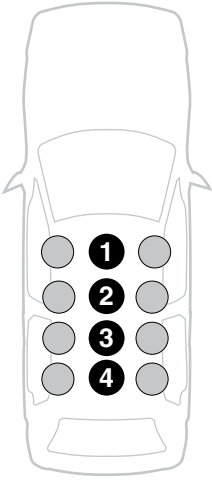

A

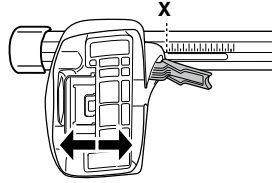

B

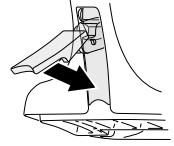

	X
1	59.5
2	59
3	57.5
4	54.5



480R



480

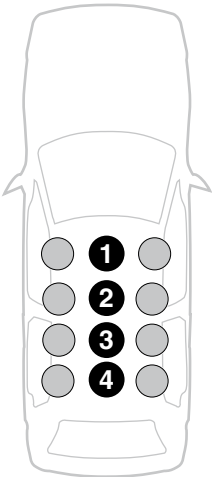

A

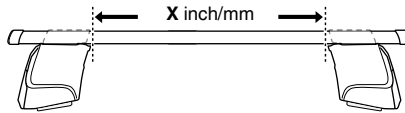

B

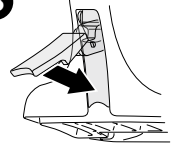

	X inch	X mm
1	49"	1246 mm
2	48 <sup>7</sup> / <sub>8</sub> "	1241 mm
3	48 <sup>1</sup> / <sub>4</sub> "	1226 mm
4	47 <sup>1</sup> / <sub>8</sub> "	1196 mm

4



480R/754



480

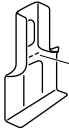

1068 x 4

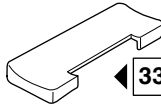

335 x 4



x 1

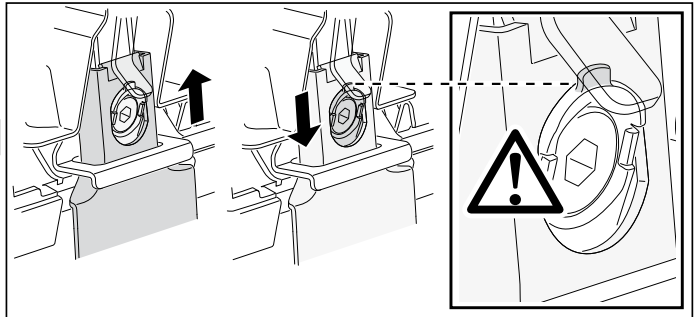
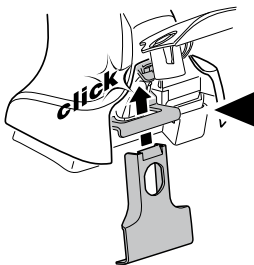
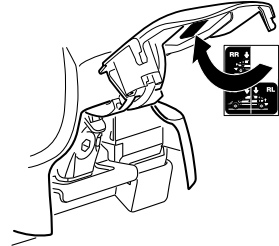
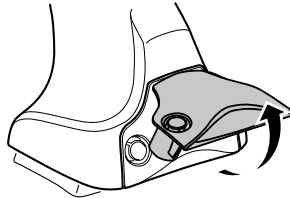
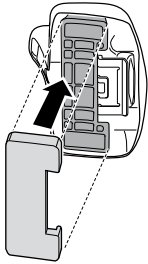

5

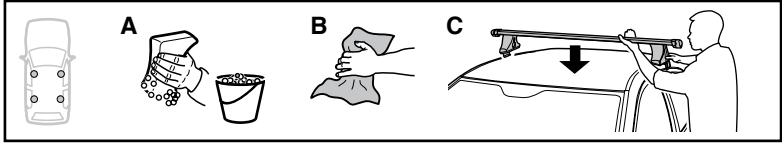

	inch	mm
<b>A</b>	11 <sup>3</sup> / <sub>4</sub> "	300 mm
<b>B</b>	39 <sup>3</sup> / <sub>8</sub> "	1000 mm
<b>C</b>	66 <sup>7</sup> / <sub>8</sub> "	1700 mm
<b>D</b>	94 <sup>1</sup> / <sub>2</sub> "	2400 mm

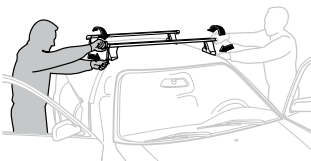
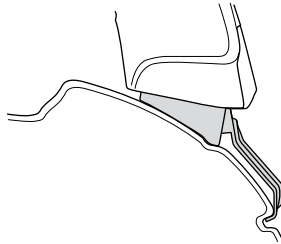
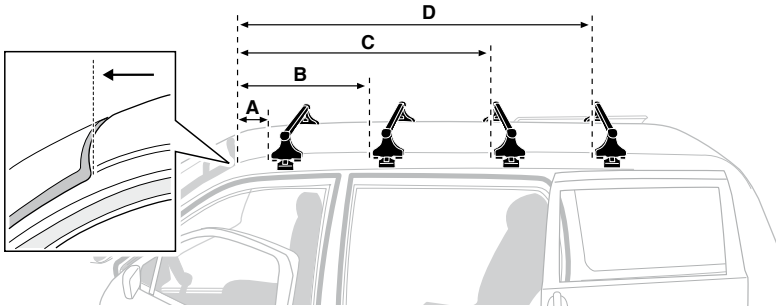

- |              |   |            |   |
|--------------|---|------------|---|
| <b>GB/US</b> | Tighten alternately                                     | <b>CZ</b>  | Pokreťta bagazníka dokrečaj dokrečaj naprzemiennie. |
| <b>D</b>     | Die Schrauben abwechselnd anziehen                      | <b>SK</b>  | Dotahujte striedavo                                 |
| <b>F</b>     | Serrer alternativement chaque côté                      | <b>SLO</b> | Privijajte izmenično.                               |
| <b>NL</b>    | Afwisselend aan de linker- en de rechterkant aandraaien | <b>HR</b>  | Naizmjenično zategnite                              |
| <b>I</b>     | Alternare il serraggio delle viti                       | <b>HU</b>  | Egymástól függetlenül szoritandó                    |
| <b>E</b>     | Apretar alternativamente                                | <b>GR</b>  | Σφιγγείτε εναλλάξ                                   |
| <b>PT</b>    | Aperte alternadamente                                   | <b>TR</b>  | Dönüşümlü sıkın                                     |
| <b>S</b>     | Dra åt växelvis   | <b>中文</b>  | 交替拧紧  |
| <b>FIN</b>   | Kierrä vuorotellen                                      | <b>한국어</b> | 번갈아 가며 조이십시오.                                       |
| <b>EST</b>   | Pinguldage vaheldumisi                                  | <b>日本語</b> | 交互に締め付けてください。                                       |
| <b>LAT</b>   | Pielvelciēt pamišus                                     | <b>ไทย</b> | ขันในแบบสลับ  |
| <b>LIT</b>   | Užsukinėkite pakaitomis                                 |            |   |
| <b>PL</b>    | Śruby dokrećaj naprzemiennie                            |            |   |
| <b>RU</b>    | Затягивайте попеременно                                 |            |   |

6

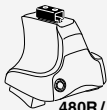

480R/754



480

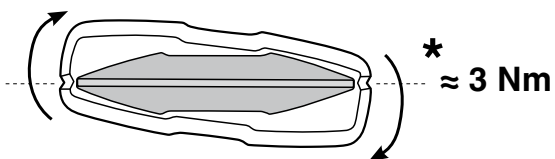
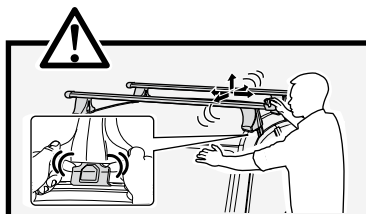
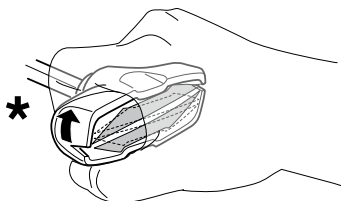
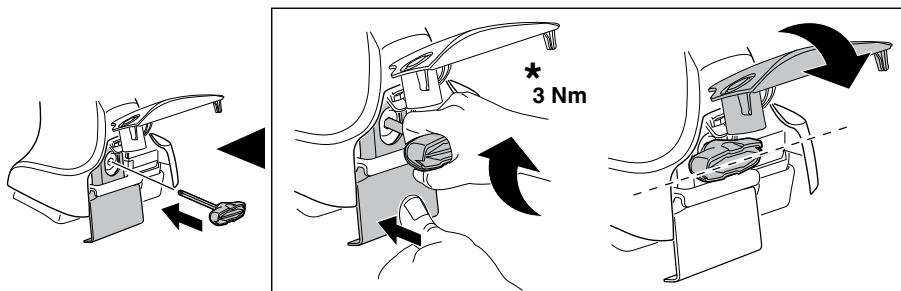

7

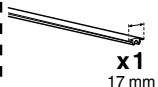

x1  
17 mm

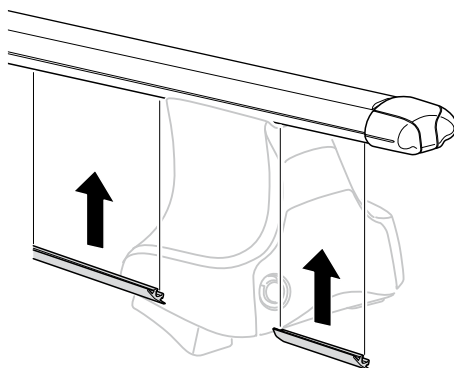

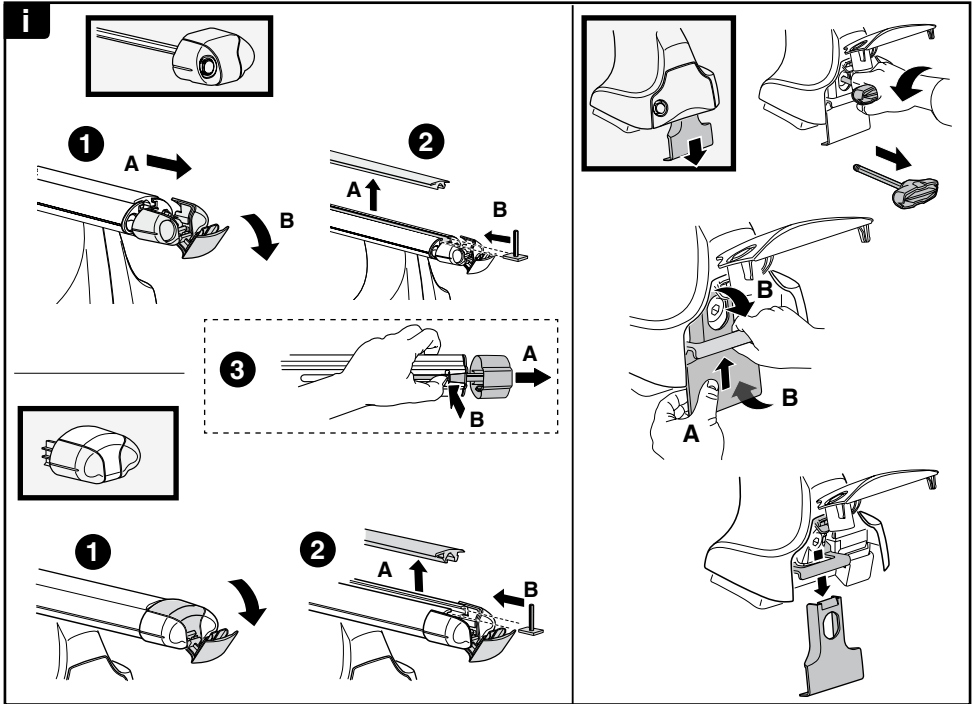
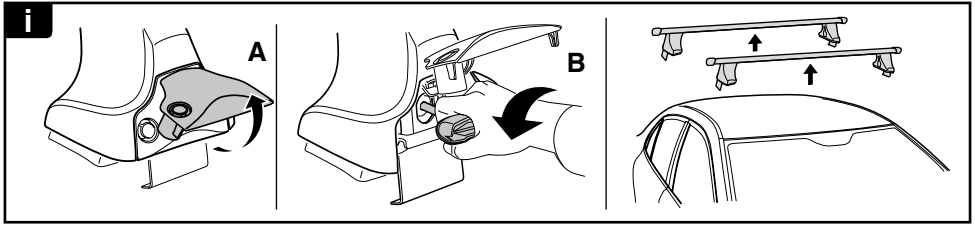

**THULE**  
SWEDEN  
**ONE  
KEY  
SYSTEM**

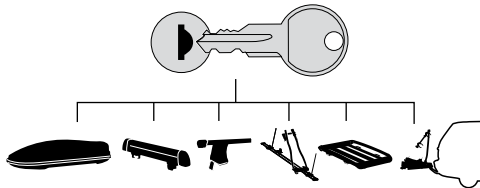

- 544** (x4)
- 596** (x6)
- 588** (x8)
- NA **510** (x10)
- EUR **452** (x12)
- ASIA

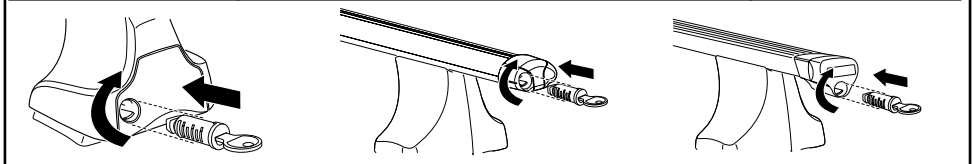

WW ▶ Thule Sweden AB, Box 69, 330 33 Hillerstorp, SWEDEN  
NA ▶ Thule Inc., 42 Silvermine Road, Seymour, Connecticut 06483, USA

info@thule.com  
customer.service@thule.com

www.thule.com



[www.thuleprofessional.com](http://www.thuleprofessional.com)

[info@thule.com](mailto:info@thule.com)  
[customer.service@thule.com](mailto:customer.service@thule.com)

**NA** Thule Inc., 42 Silvermine Road, Seymour, Connecticut 06483, USA  
**SW** Thule Sweden AB, Box 69, 330 33 Hillerstorp, SWEDEN

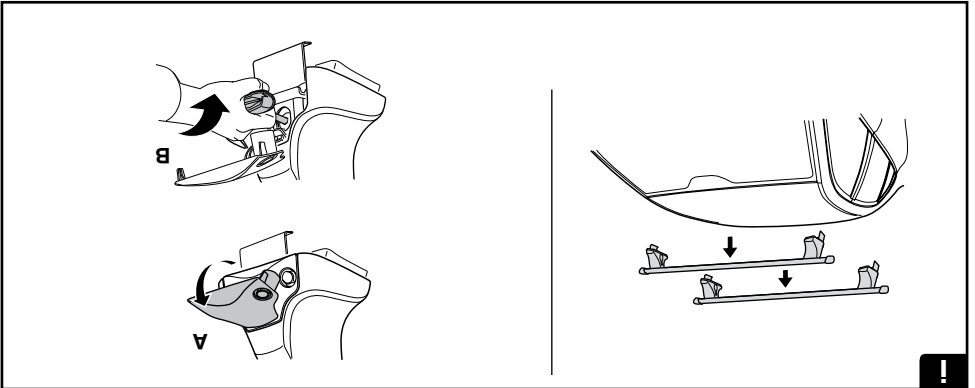
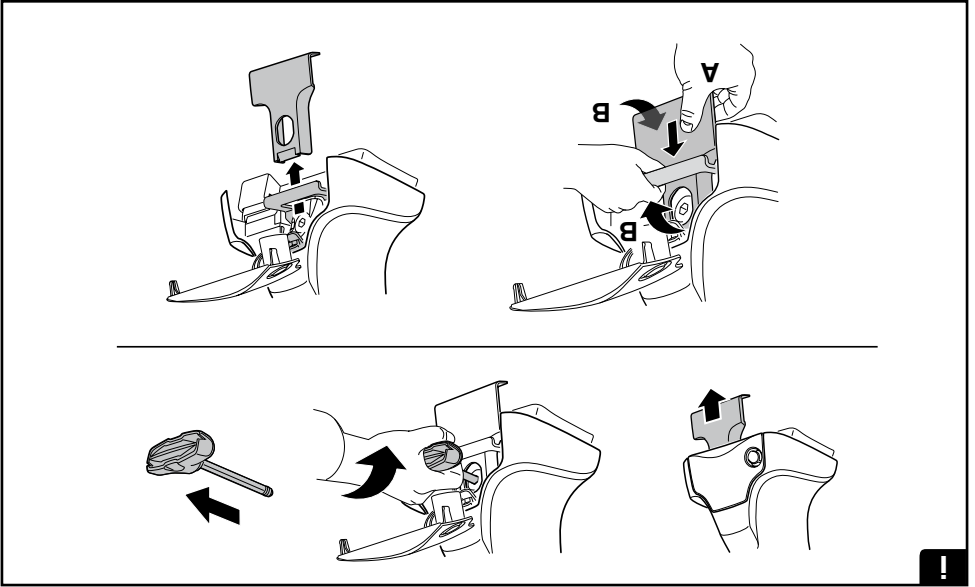

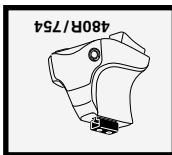
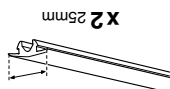
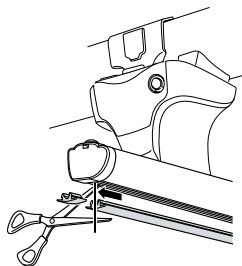
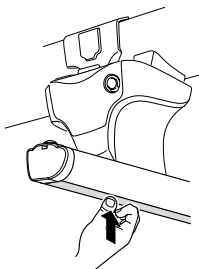
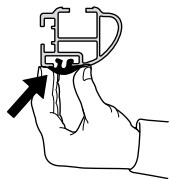

8

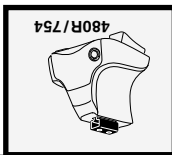
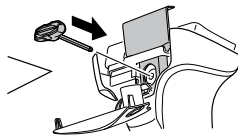
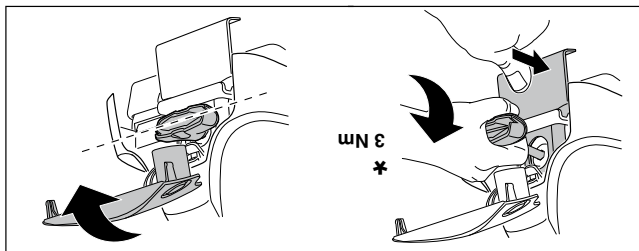
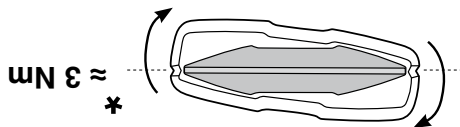
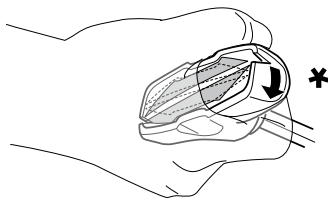
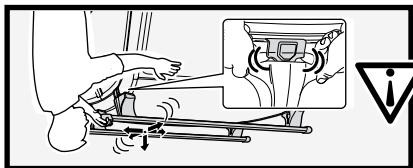

7

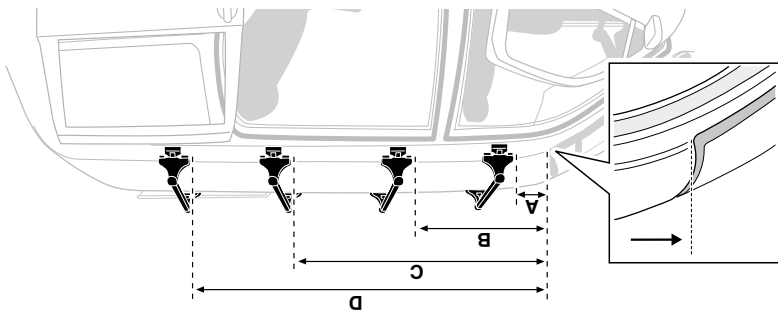
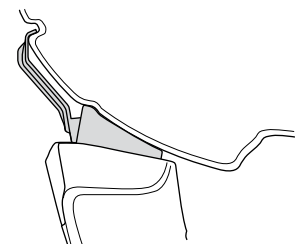
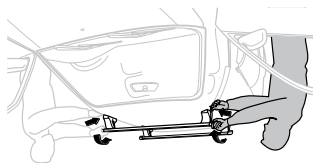

<b>D</b>	94 1/2"	2400 mm
<b>C</b>	66 7/8"	1700 mm
<b>B</b>	39 3/8"	1000 mm
<b>A</b>	11 3/4"	300 mm
	inch	mm

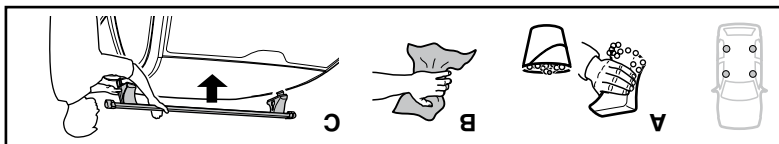

6

GB/US Tighten alternately  
D Die Schrauben abwechselnd  
F anziehen  
NL Serrer alternatiewent  
I rechterkant aandraaien  
E Alternare il serraggio delle viti  
PT Aperte alternadamente  
S Dra åt växevävis  
FIN Kierä vuorotellen  
EST Pinguldage vaheldumisi  
LAT Pevēciēt pamīšus  
LT Uzskūnēkite pakārtomis  
PL Słubę dokręcaj naprzemiennie  
RU Затягивайте попеременно

CZ Počkejte bagazníka dokręcaj dokręcaj naprzemiennie.  
SK Dotiahnuť stredovo  
SLO Serrer alternatiewent chaque côté  
HU Nálmezőre zategnit.  
HR Najzmišćo zategnit.  
SLO Privajite izmenično.  
GR Σφύγστε εναλλάξ  
TR Dönüşümü skin  
中文 交替拧紧  
한국어 번갈아 가며 조이십시오.  
日本語 交互に締め付けてください。  
ᠮᠠᠨᠠᠯᠠᠵᠢᠨᠠᠯᠠᠵᠢ

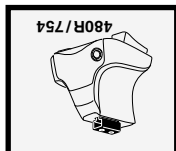
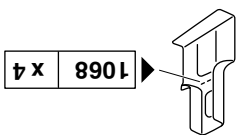
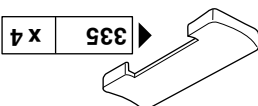
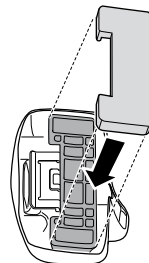
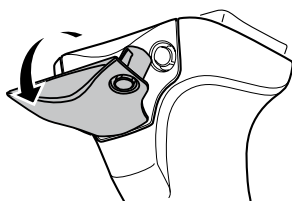
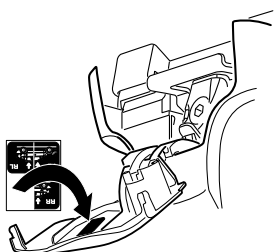
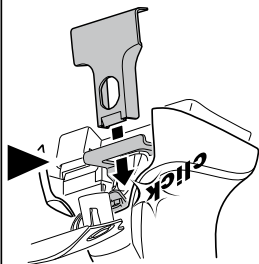
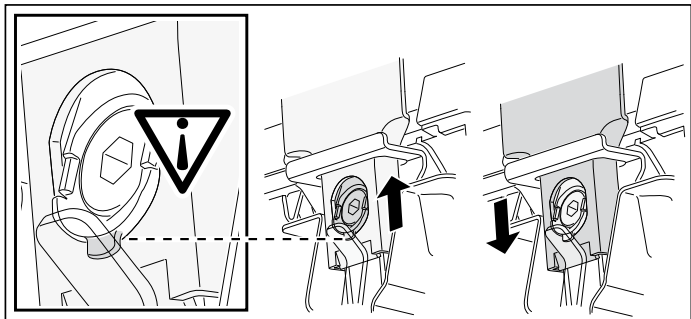

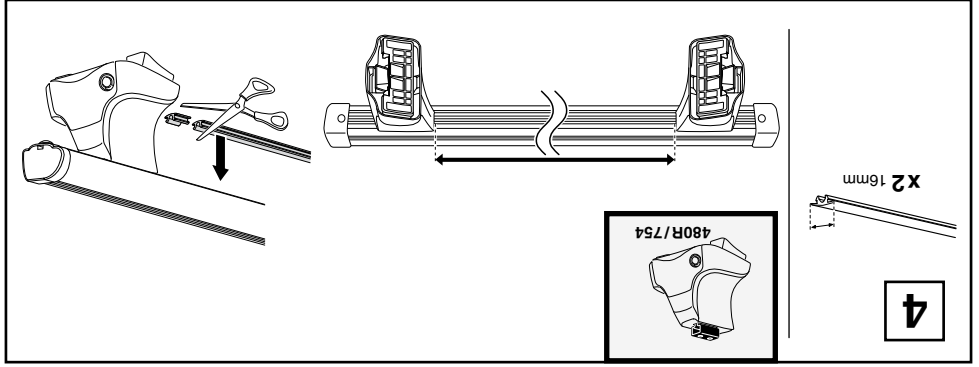

**4**

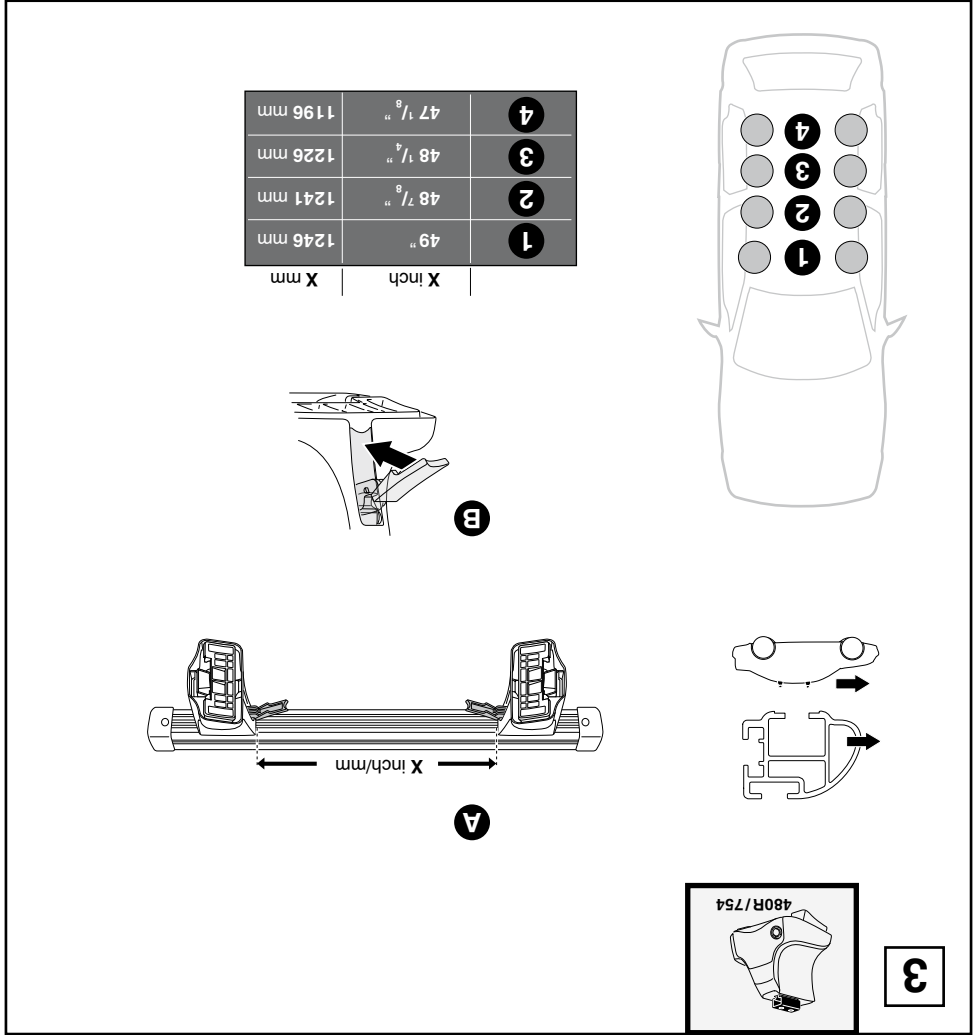

**3**

1	49"	1246 mm
2	48 7/8"	1241 mm
3	48 1/4"	1226 mm
4	47 1/8"	1196 mm

X mm

X inch

**A**

**B**

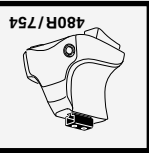

480R/754

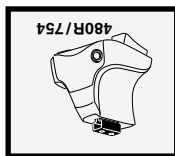
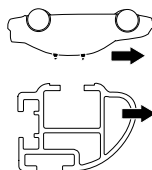
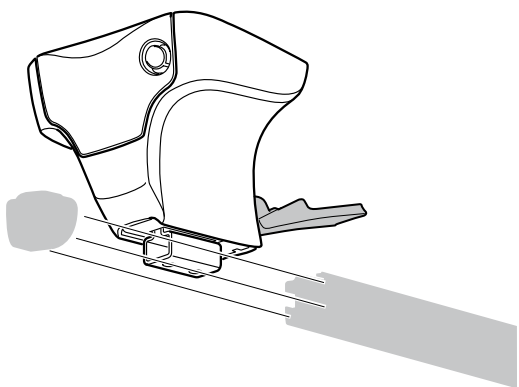
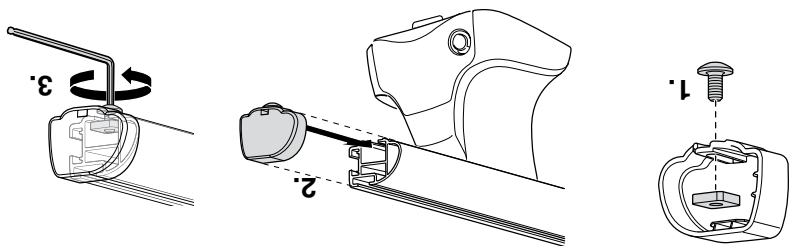

2

-  X1 5mm
-  X4
-  X4
-  X2
-  X2

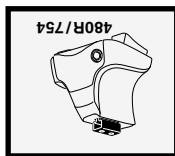
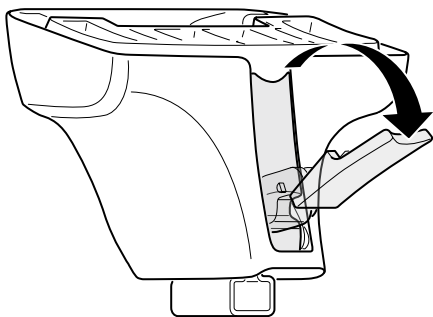

1

**Kit**

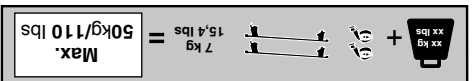
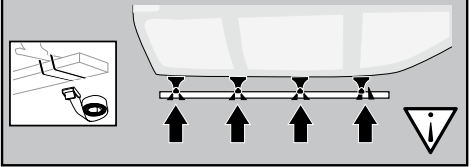
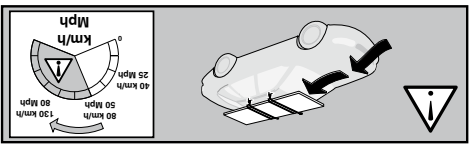
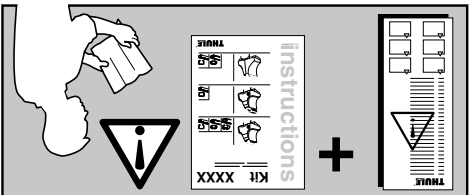
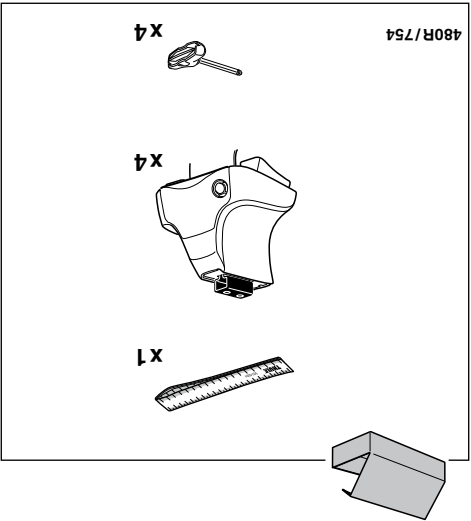
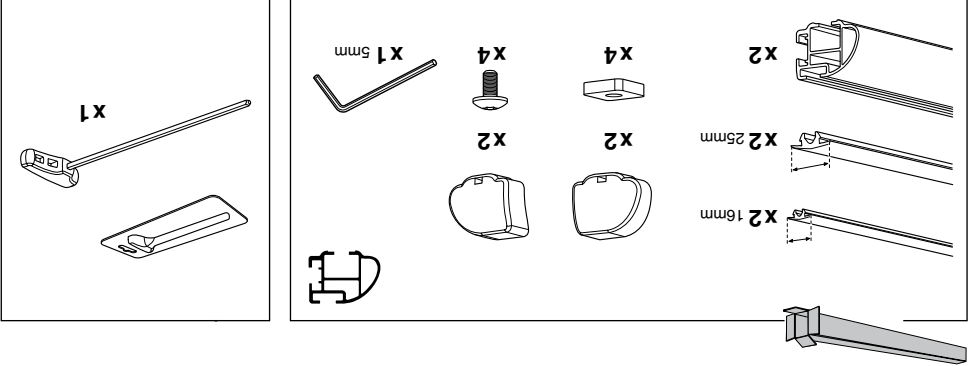
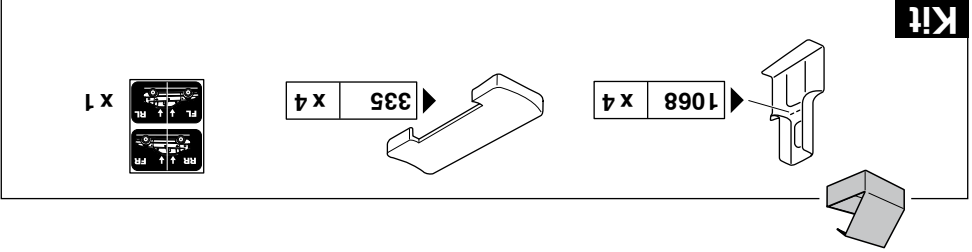

# instructions

20100507: 503-1572

# Kit 1572

VW Transporter T4, 4-dr Van, 91-96, 97-02  
VW Eurovan, 4-dr Van, \*92-03  
\*North America

480R  
754

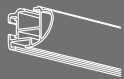
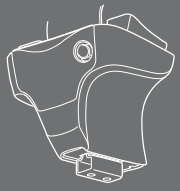

ISO 11154-E

**THULE**  
SWEDEN  
PROFESSIONAL