

# Kit 1574

**SUBARU Legacy**, 4-dr Sedan, 09- / \*10-

**SUBARU Liberty**, 4-dr Sedan, 09-

**SUBARU Outback**, 4-dr Sedan, \*10-

\*North America

480R  
754

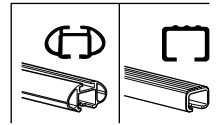
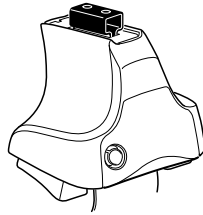

480

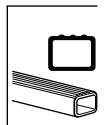
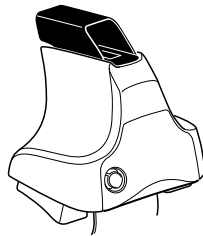

**THULE**<sup>®</sup>  
SWEDEN

ISO 11154-E

480R/754

480

**Kit**

1

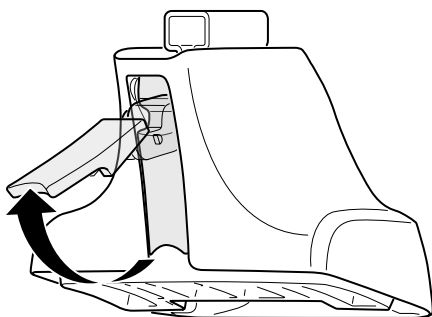
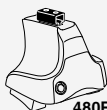

2



+

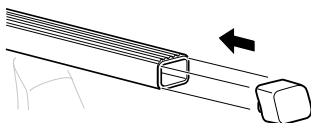
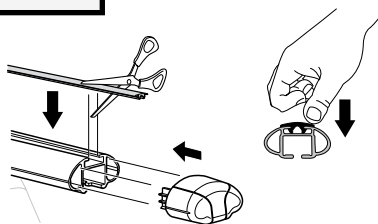
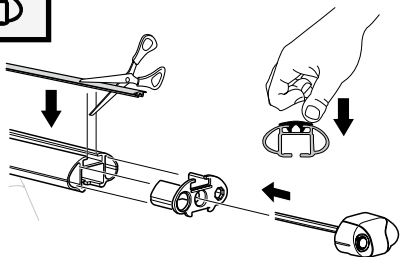
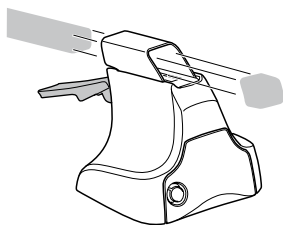
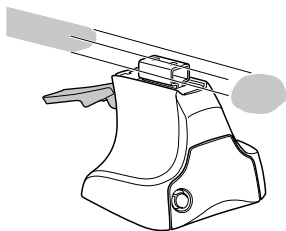

**3**

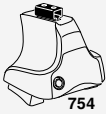

754

**1**

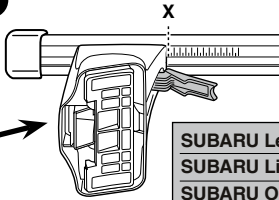
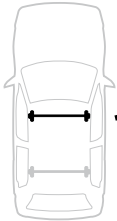

**2**

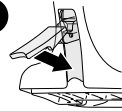

	X
SUBARU Legacy, 4-dr Sedan, 09- / *10-	44
SUBARU Liberty, 4-dr Sedan, 09-	44
SUBARU Outback, 4-dr Sedan, *10-	44

**1**

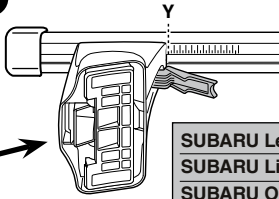

**2**

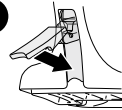

	Y
SUBARU Legacy, 4-dr Sedan, 09- / *10-	40,5
SUBARU Liberty, 4-dr Sedan, 09-	40,5
SUBARU Outback, 4-dr Sedan, *10-	40,5



480R

480

**1**

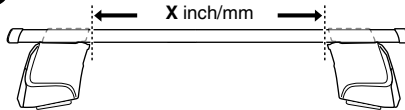

**2**

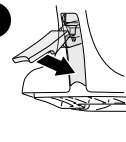

	X inch	X mm
SUBARU Legacy, 4-dr Sedan, 09- / *10-	43"	1091 mm
SUBARU Liberty, 4-dr Sedan, 09-	43"	1091 mm
SUBARU Outback, 4-dr Sedan, *10-	43"	1091 mm

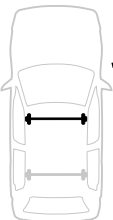

**1**

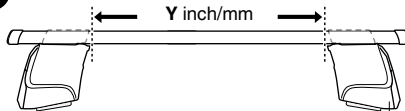

**2**

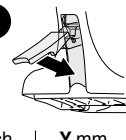

	Y inch	Y mm
SUBARU Legacy, 4-dr Sedan, 09- / *10-	41 <sup>5</sup> / <sub>8</sub> "	1056 mm
SUBARU Liberty, 4-dr Sedan, 09-	41 <sup>5</sup> / <sub>8</sub> "	1056 mm
SUBARU Outback, 4-dr Sedan, *10-	41 <sup>5</sup> / <sub>8</sub> "	1056 mm



4

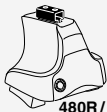

480R/754



480

SUBARU Legacy, 4-dr Sedan, 09-/\*10-  
SUBARU Liberty, 4-dr Sedan, 09-  
SUBARU Outback, 4-dr Sedan, \*10-

121



202

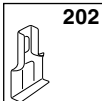

120



202

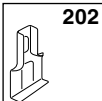

120



368

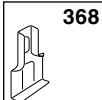

121



368

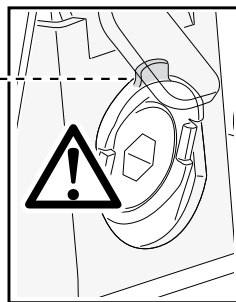
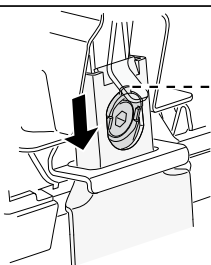
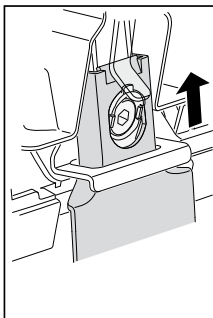
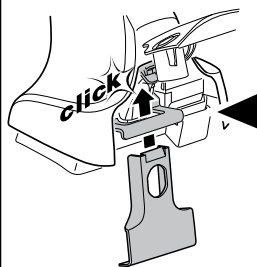
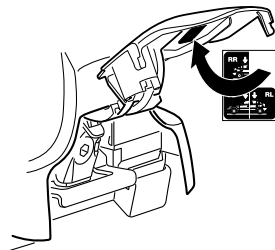
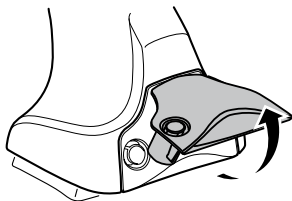
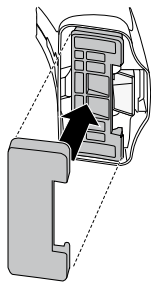
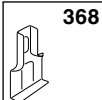

5



	X mm	Y mm	X inch	Y inch
<b>SUBARU Legacy, 4-dr Sedan, 09- / *10-</b>	270 mm	700 mm	10 <sup>5</sup> / <sub>8</sub> "	27 <sup>1</sup> / <sub>2</sub> "
<b>SUBARU Liberty, 4-dr Sedan, 09-</b>	270 mm	700 mm	10 <sup>5</sup> / <sub>8</sub> "	27 <sup>1</sup> / <sub>2</sub> "
<b>SUBARU Outback, 4-dr Sedan, *10-</b>	270 mm	700 mm	10 <sup>5</sup> / <sub>8</sub> "	27 <sup>1</sup> / <sub>2</sub> "

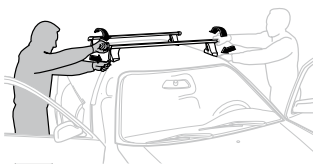
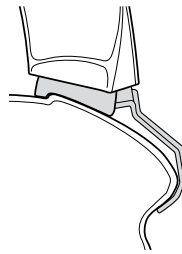
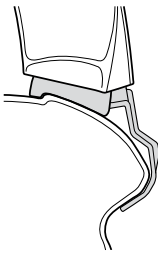
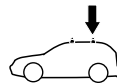
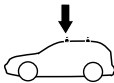
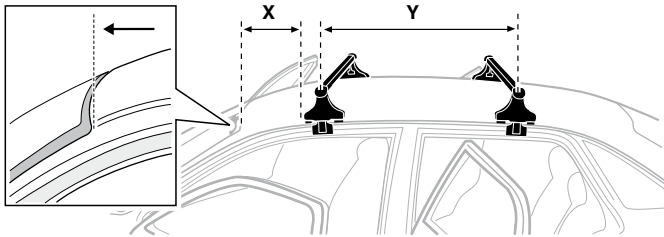

- GB/US** Tighten alternately  
**D** Die Schrauben abwechselnd anziehen  
**F** Serrer alternativement chaque côté  
**NL** Afwisselend aan de linker- en de rechterkant aandraaien  
**I** Alternare il serraggio delle viti  
**E** Apretar alternativamente  
**PT** Aperte alternadamente  
**S** Dra åt växelvis  
**FIN** Kierrä vuorotellen  
**EST** Pinguldage vaheldumisi  
**LAT** Pielvelciēt pamišus  
**LIT** Užsukinėkite pakaitomis  
**PL** Śruby dokręcaj naprzemiennie  
**RU** Затягивайте попеременно

- CZ** Pokrétla bagażnika dokręcaj dokręcaj naprzemiennie.  
**SK** Dofahujte striedavo  
**SLO** Privijajte izmenično.  
**HR** Naizmjenično zategnite  
**HU** Egyarástól függetlenül szorítandó  
**GR** Σφιγγετε εναλλάξ  
**TR** Dönüşümlü sıkın

**中文** 交替拧紧

**한국어** 번갈아 가며 조이십시오.

**日本語** 交互に締め付けてください。

**ไทย** สลับขันในแบบสลับ

6

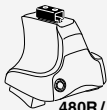

480R/754



480

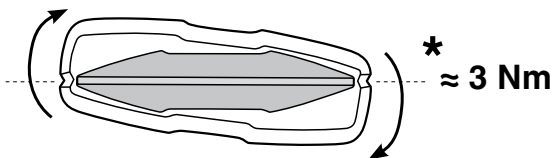
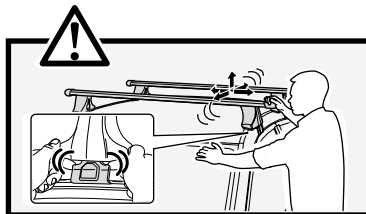
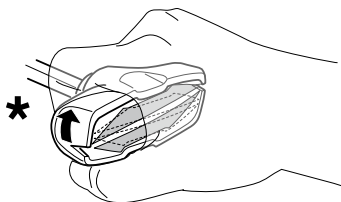
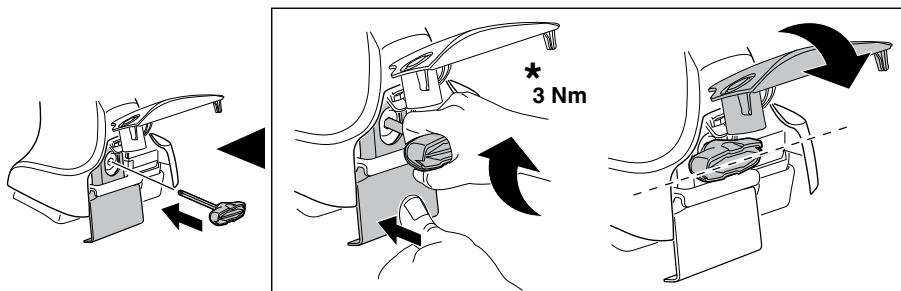

7

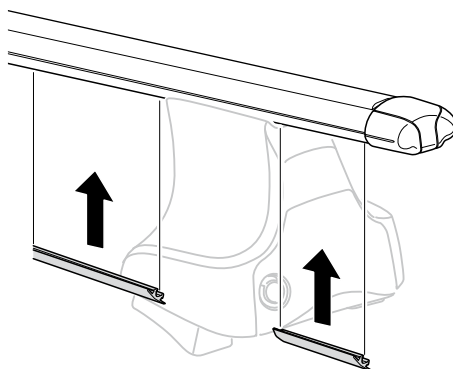
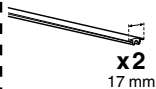

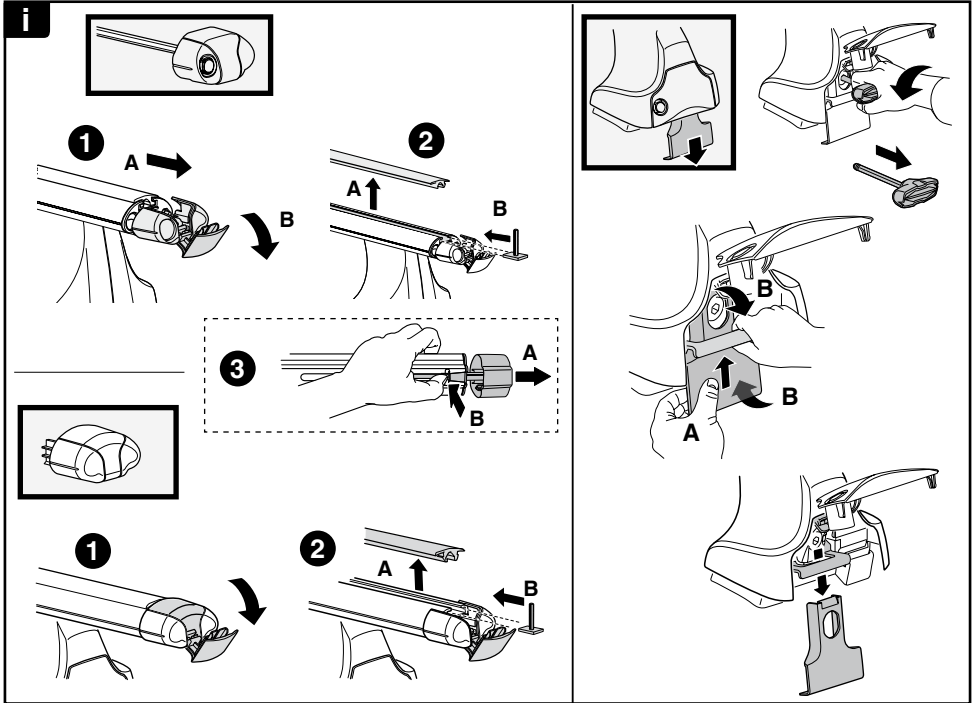

**THULE**  
SWEDEN  
**ONE  
KEY  
SYSTEM**

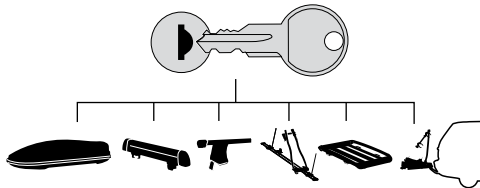

- 544** (x4)
- 596** (x6)
- 588** (x8)
- NA **510** (x10)
- EUR **452** (x12)
- ASIA

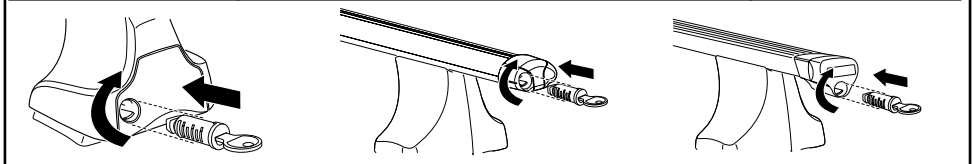

WW ▶ Thule Sweden AB, Box 69, 330 33 Hillerstorp, SWEDEN  
NA ▶ Thule Inc., 42 Silvermine Road, Seymour, Connecticut 06483, USA

info@thule.com  
customer.service@thule.com

www.thule.com