

Kit 1592

VOLKSWAGEN Passat, 4-dr Sedan, 05-09, 10- / *06-
***North America**

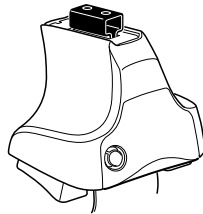

754 Rapid System
480R Rapid Traverse (North America)

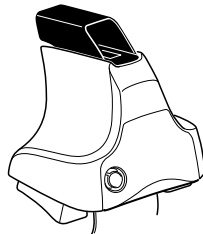
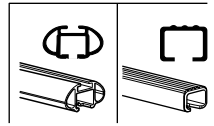

480 Traverse (North America)

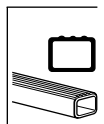

1

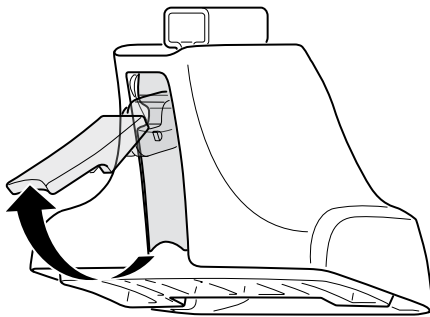

2



754 Rapid System
480R Rapid Traverse
(North America)

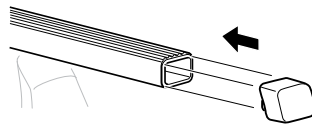
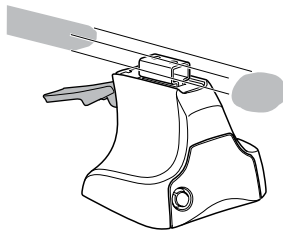

x4

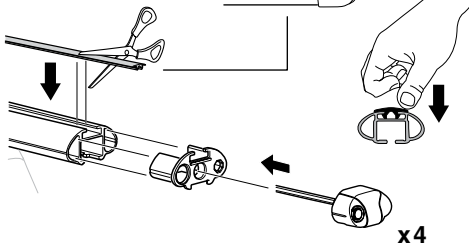
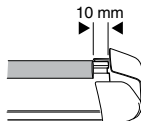
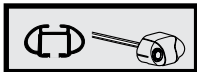

x4

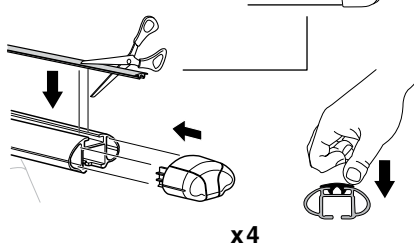
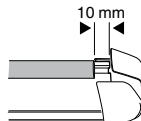
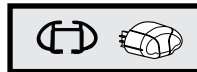

x4



480 Traverse
(North America)

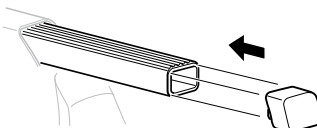
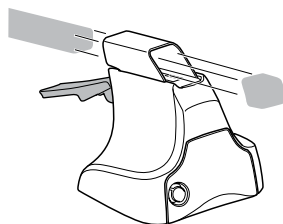

x4

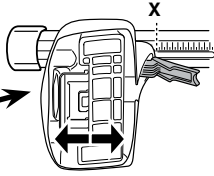
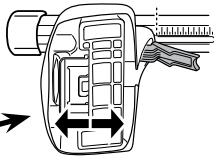
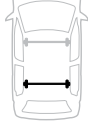
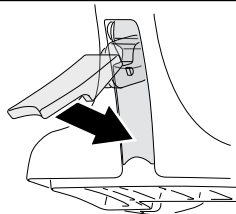
3**754** Rapid System**X****VOLKSWAGEN Passat, 4-dr Sedan, 05-09, 10- / *06-****X****40,5****Y****VOLKSWAGEN Passat, 4-dr Sedan, 05-09, 10- / *06-****Y****39****3****480R** Rapid Traverse**480** Traverse**(North America)****X inch/mm****X inch****X mm****VOLKSWAGEN Passat, 4-dr Sedan, 05-09, 10- / *06-****41 ⁵/₈ "****1056 mm****Y inch/mm****Y inch****Y mm****VOLKSWAGEN Passat, 4-dr Sedan, 05-09, 10- / *06-****41 "****1041 mm****4**

5

VOLKSWAGEN Passat, 4-dr Sedan, 05-09, 10- / *06-

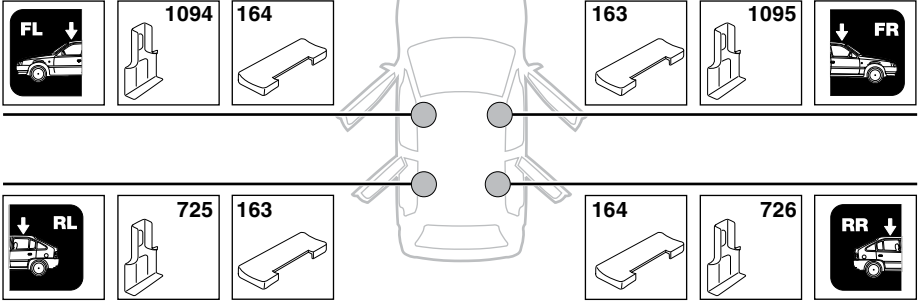

6

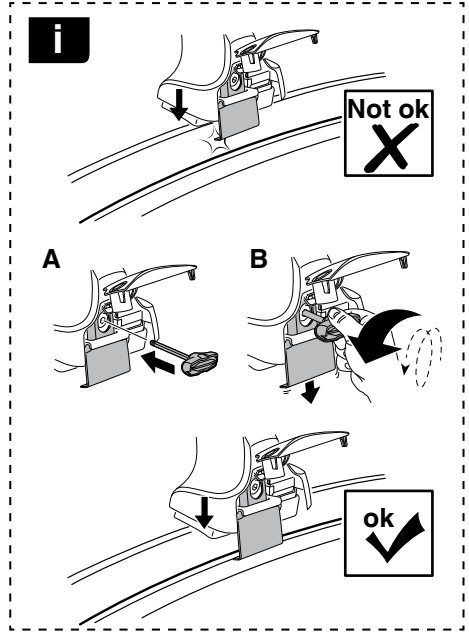

	X mm	Y mm	X inch	Y inch
VOLKSWAGEN Passat, 4-dr Sedan, 05-09, 10- / *06-	270 mm	775 mm	10 ⁵ / ₈ "	30 ¹ / ₂ "

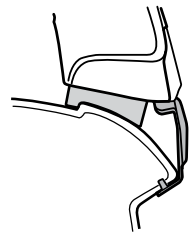
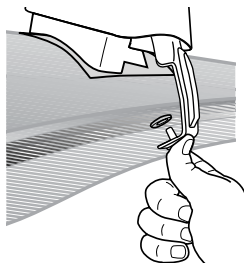
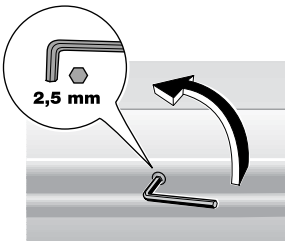
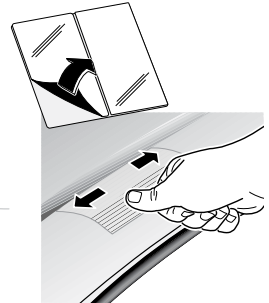
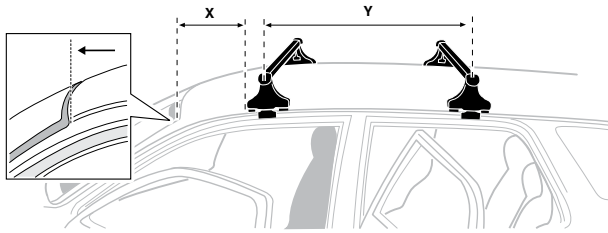

7

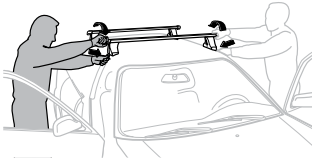

GB/US Tighten alternately
 D Die Schrauben abwechselnd anziehen
 F Serrer alternativement chaque côté
 NL Afwisselend aan de linker- en de rechterkant aandraaien
 I Alternare il serraggio delle viti
 E Apretar alternativamente
 PT Aperte alternadamente
 S Dra åt växelvis
 FIN Kierrä vuorotellen
 EST Pinguldage vaheldumisi
 LAT Pievelciēt pamišus
 LIT Užsukinėkite pakaitomis
 PL Śruby dokręcaj naprzemiennie
 RU Затягивайте попеременно

CZ Pokręťta bagażnika dokręcaj dokręcaj naprzemiennie.
 SK Doťahujte striedavo
 SLO Privijajte izmenično.
 HR Naizmjenično zategnite
 HU Egymástól függetlenül szorítandó
 GR Σφιγγεται εναλλάξ
 TR Dönüşümlü sıkın

中文 交替拧紧

한국어 번갈아 가며 조이십시오.

日本語 交互に締め付けてください。

ไทย ชั้้นในแบบสลับ

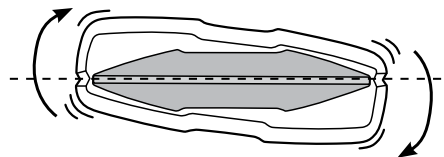
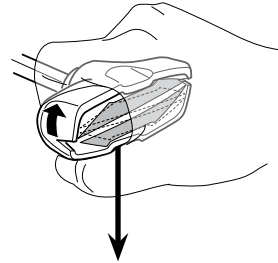
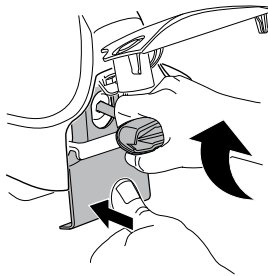
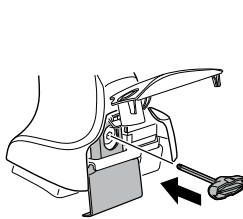

≈ 3 Nm

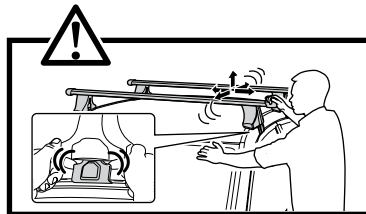
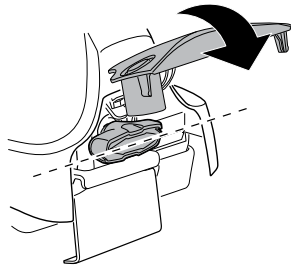

8



x1
17 mm

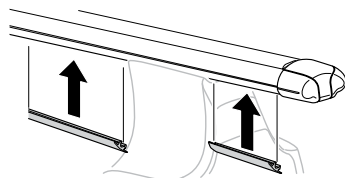



THULE
SWEDEN
**ONE
KEY
SYSTEM**



		(x4)
		(x6)
		(x8)
NA		(x10)
EUR		(x12)
ASIA		



WW ▶ Thule Sweden AB, Box 69, 330 33 Hillerstorp, SWEDEN
NA ▶ Thule Inc., 42 Silvermine Road, Seymour, Connecticut 06483, USA

info@thule.com
customer.service@thule.com

www.thule.com