

Kit 1651

AUDI A6, 4-dr Sedan, 11-



754 Rapid System
480R Rapid Traverse (North America)



480 Traverse (North America)



1



2



754 Rapid System
480R Rapid Traverse
(North America)



x4

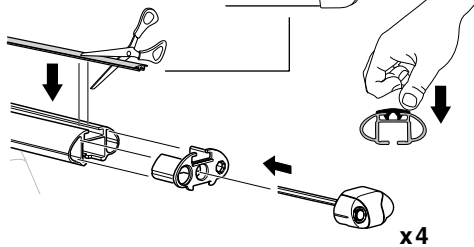
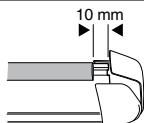

x4

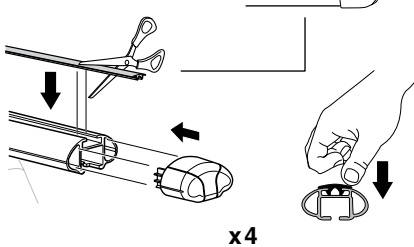
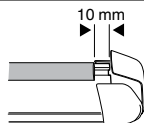
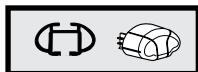

x4



480 Traverse
(North America)

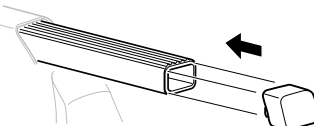
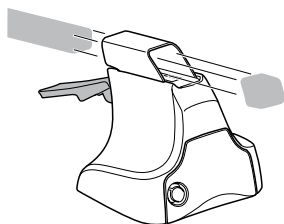

x4

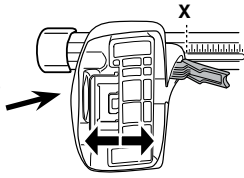
3**754** Rapid System

	X
AUDI A6, 4-dr Sedan, 11-	40

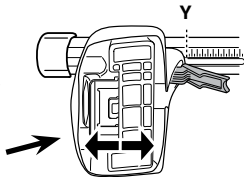

	Y
AUDI A6, 4-dr Sedan, 11-	39

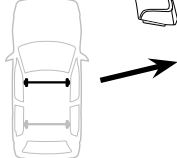
3**480R** Rapid Traverse**480** Traverse**(North America)**

	X inch	X mm
AUDI A6, 4-dr Sedan, 11-	41 ³/₈ "	1051 mm

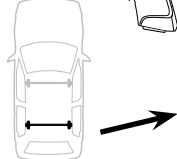

	Y inch	Y mm
AUDI A6, 4-dr Sedan, 11-	41 "	1041 mm

4

5

AUDI A6, 4-dr Sedan, 11-

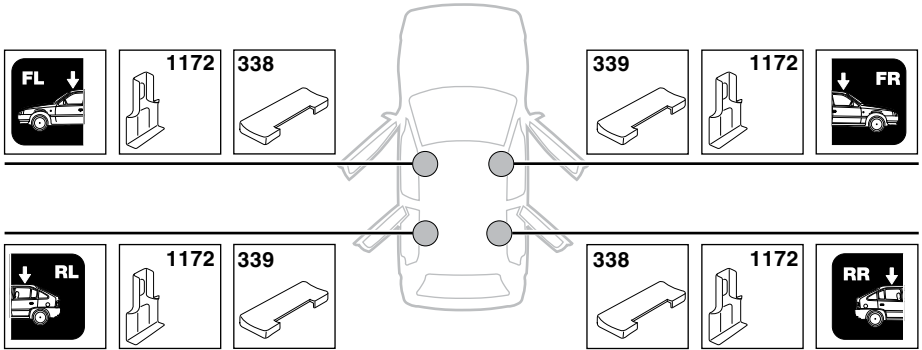

6

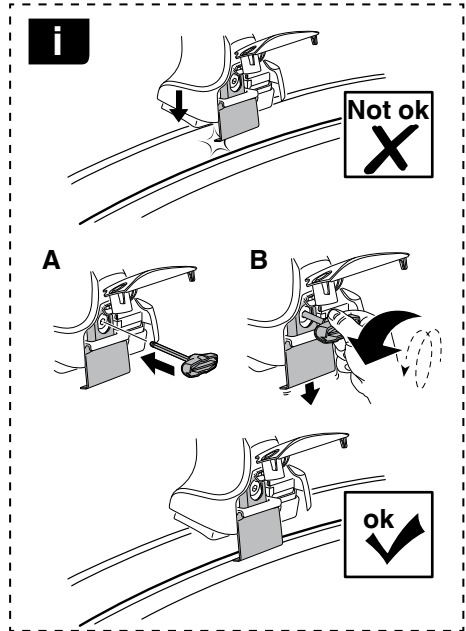
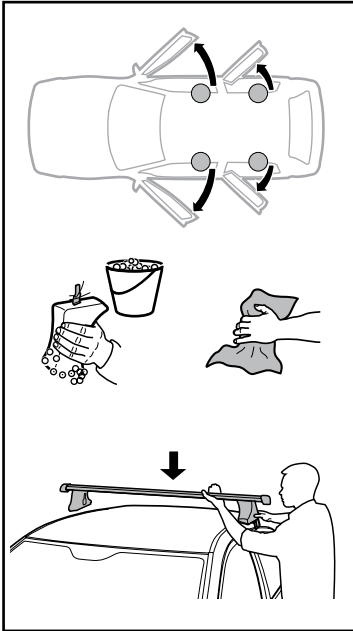
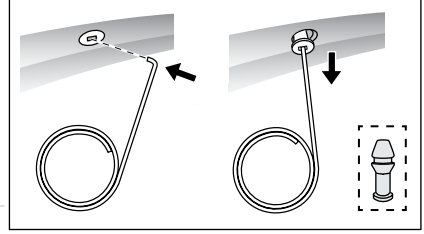
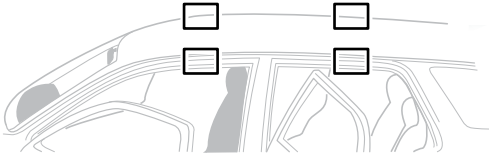
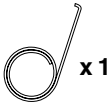

AUDI A6, 4-dr Sedan, 11-

X mm

Y mm

X inch

Y inch

270 mm

725 mm

10 ⁵/₈"

28 ¹/₂"

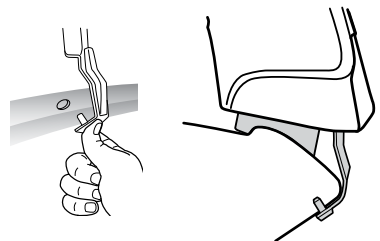
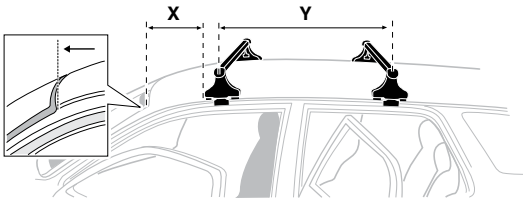

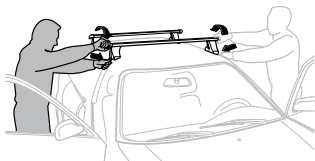
7

GB/US Tighten alternately
D Die Schrauben abwechselnd anziehen
F Serrer alternativement chaque côté
NL Afwisselend aan de linker- en de rechterkant aandraaien
I Alternare il serraggio delle viti
E Apretar alternativamente
PT Aperte alternadamente
S Dra åt växelvis
FIN Kierrä vuorotellen
EST Pinguldage vaheldumisi
LAT Pielveiciet pamišus
LIT Užsukinėkite pakaitomis
PL Śruby dokręcaj naprzemiennie
RU Затягивайте попеременно

CZ Pokręťta bagażnika dokręcaj naprzemiennie.
SK Dofahajte striedavo
SLO Privijajte izmenično.
HR Naizmjenično zategnite
HU Egymástól fűggetlenül szorítandó
GR Σφιγίγες εναλλάξ
TR Dönüşümlü sıkın

中文 交替拧紧

한국어 번갈아 가며 조이십시오.

日本語 交互に締め付けてください。

ไทย ชันในแบบสลับ

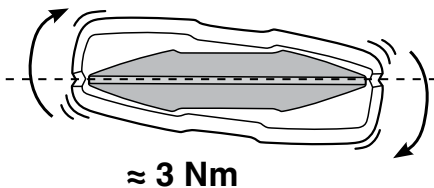
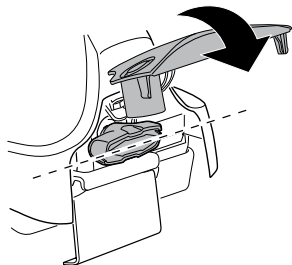
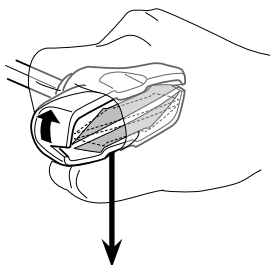
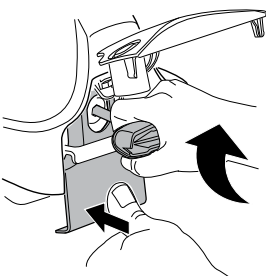
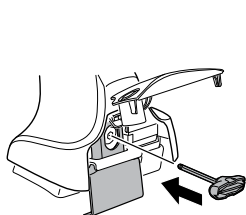

≈ 3 Nm

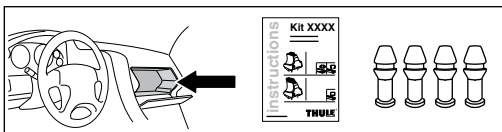
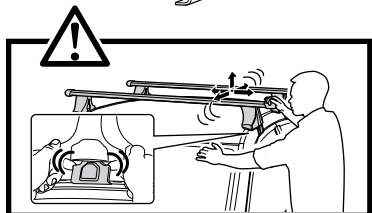
**8**

x1
17 mm

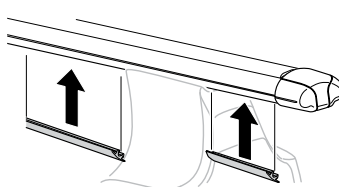
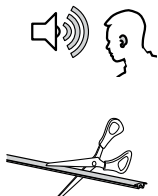

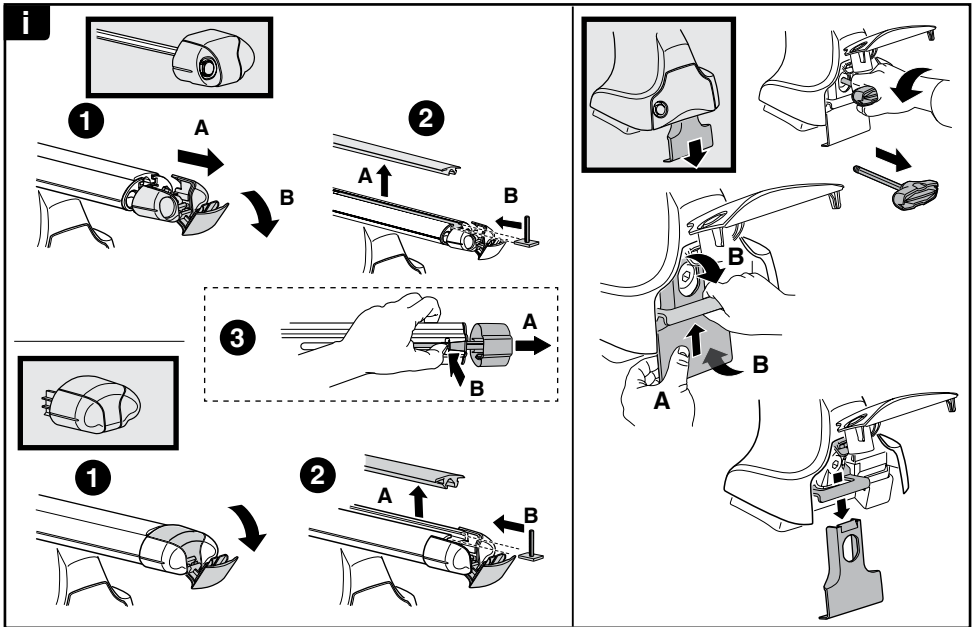
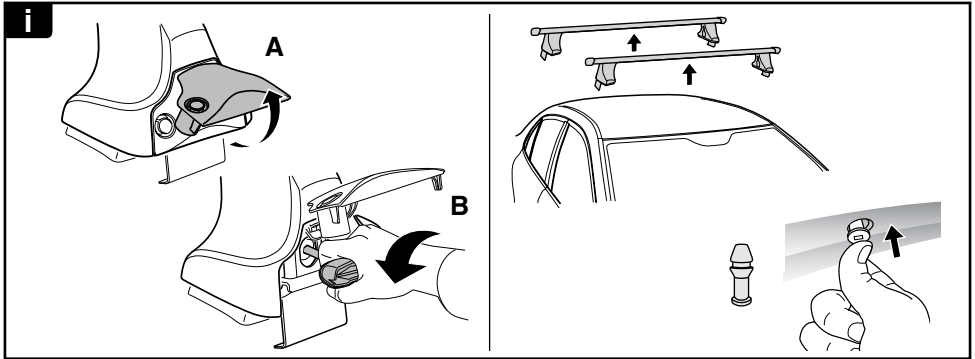

THULE
SWEDEN
**ONE
KEY
SYSTEM**

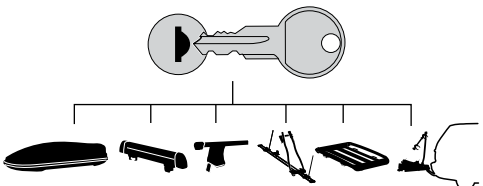

-  **544** (x4)
 -  **596** (x6)
 -  **588** (x8)
 -  **510** (x10)
 -  **452** (x12)
- NA
EUR
ASIA

