

# Kit 1689

LEXUS GS250, 4-dr Sedan, 12-

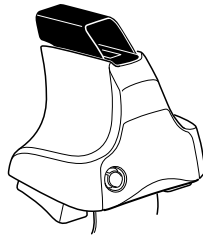

**754** Rapid System  
**480R** Rapid Traverse (North America)



**480** Traverse (North America)

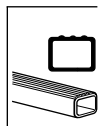

- 754 Rapid System: x1 (box), x4 (weight), x4 (weight)
- 480R Rapid Traverse (North America): x4 (weight), x4 (weight)
- 754 Rapid System: x1 (ruler), x4 (weight), x4 (weight)
- 480R Rapid Traverse (North America): x1 (ruler), x4 (weight), x4 (weight)

- Traverse (North America): x2 (weight), x2 (weight), x2 (weight), x4 (weight), x4 (weight), x1 (weight), x2 (weight), x2 (weight), x2 (weight), x2 (weight), x2 (weight), x2 (weight), x2 (weight), x2 (weight)

- 1052 x 4
- 204 x 1
- 206 x 1
- 180 x 2
- FR FL FR RL x 1

1



2



754 Rapid System  
480R Rapid Traverse  
(North America)



x4



x4



x4



480 Traverse  
(North America)

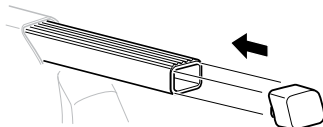

x4

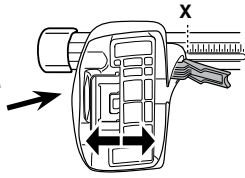
**3****754** Rapid System

	<b>X</b>
<b>LEXUS GS250, 4-dr Sedan, 12-</b>	<b>34,5</b>

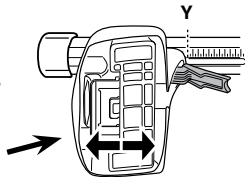

	<b>Y</b>
<b>LEXUS GS250, 4-dr Sedan, 12-</b>	<b>34</b>

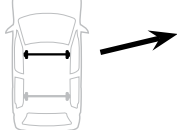
**3****480R** Rapid Traverse**480** Traverse**(North America)**

	<b>X inch</b>	<b>X mm</b>
<b>LEXUS GS250, 4-dr Sedan, 12-</b>	<b>39 1/4"</b>	<b>996 mm</b>

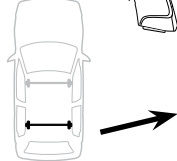

	<b>Y inch</b>	<b>Y mm</b>
<b>LEXUS GS250, 4-dr Sedan, 12-</b>	<b>39"</b>	<b>991 mm</b>

**4**

# 5

LEXUS GS250, 4-dr Sedan, 12-

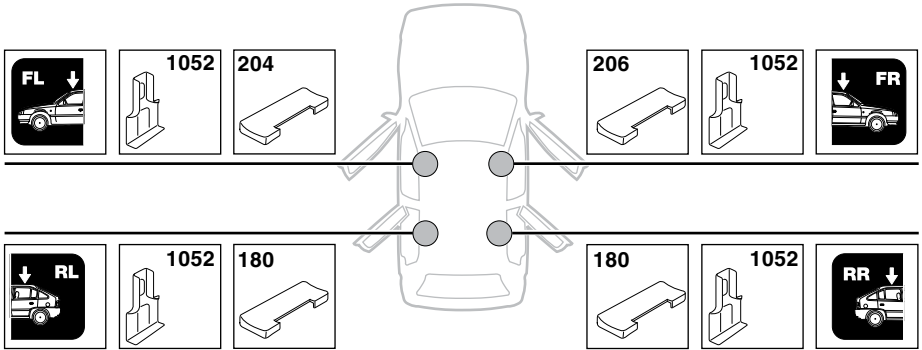

6

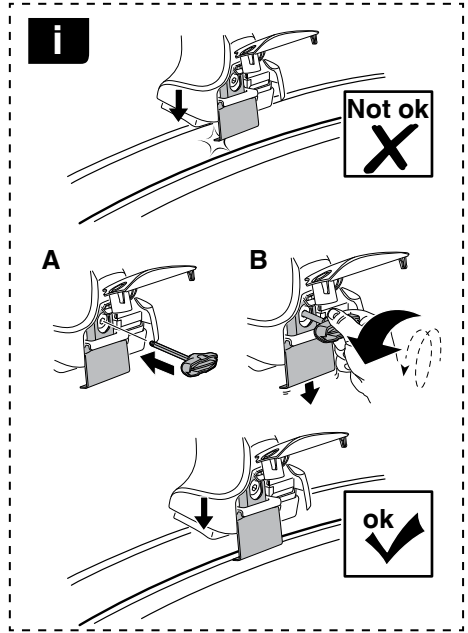

LEXUS GS250, 4-dr Sedan, 12-

X mm	Y mm	X inch	Y inch
210 mm	730 mm	8 1/4"	28 3/4"

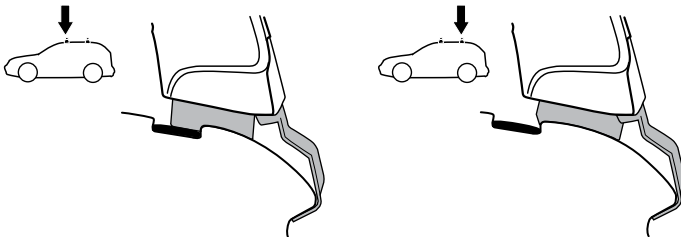
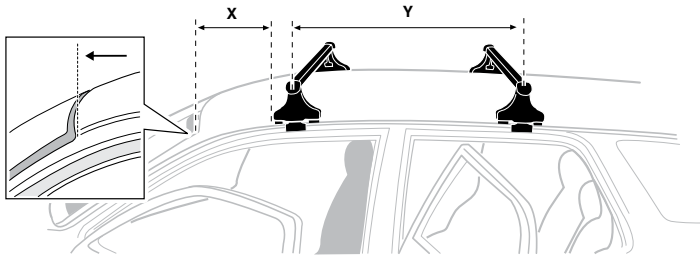

**7**

**GB/US** Tighten alternately  
**D** Die Schrauben abwechselnd anziehen  
**F** Serrer alternativement chaque côté  
**NL** Afwisselend aan de linker- en de rechterkant aandraaien  
**I** Alternare il serraggio delle viti  
**E** Apertar alternativamente  
**PT** Aperte alternadamente  
**S** Dra åt växelvis  
**FIN** Kierrä vuorotellen  
**EST** Pinguldage vaheldumisi  
**LAT** Pieļieciet pamišus  
**LIT** Užsukinėkite pakaitomis  
**PL** Śruby dokręcaj naprzemiennie  
**RU** Затягивайте попеременно

**CZ** Pokręťta bagażnika dokręcaj naprzemiennie.  
**SK** Dofahajte striedavo  
**SLO** Privijajte izmenično.  
**HR** Naizmjenočno zategnite  
**HU** Egymástól függetlenül szorítandó  
**GR** Σφιγίγτες εναλλάξ  
**TR** Dönüşümlü sıkın

**中文** 交替拧紧

**한국어** 번갈아 가며 조이십시오.

**日本語** 交互に締め付けてください。

**ไทย** ชันในแบบสลับ

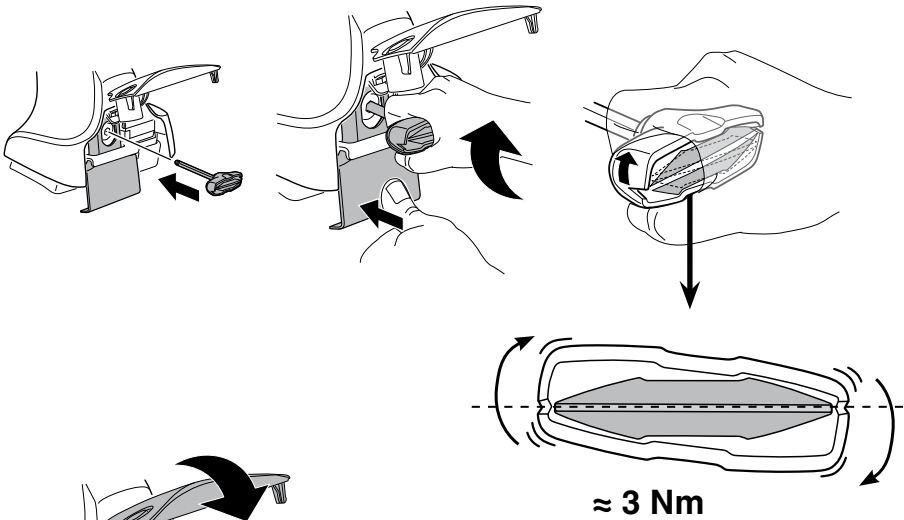
**8**

**x1**  
17 mm

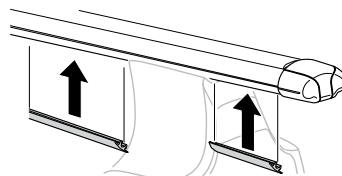
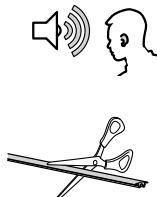

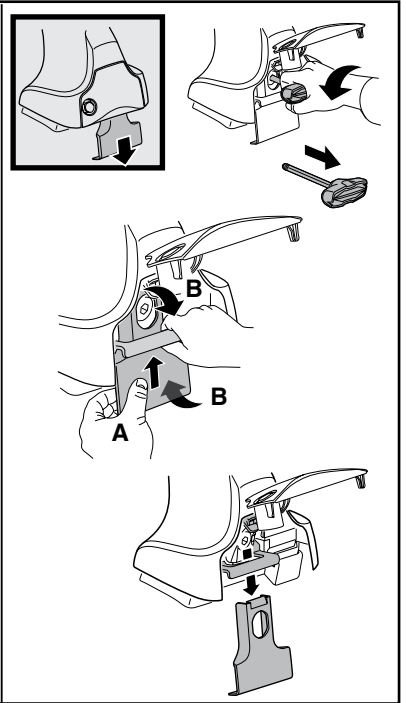
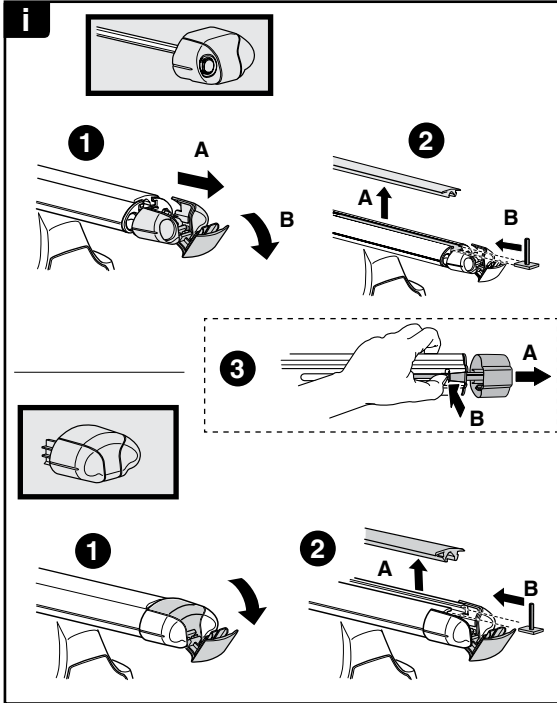
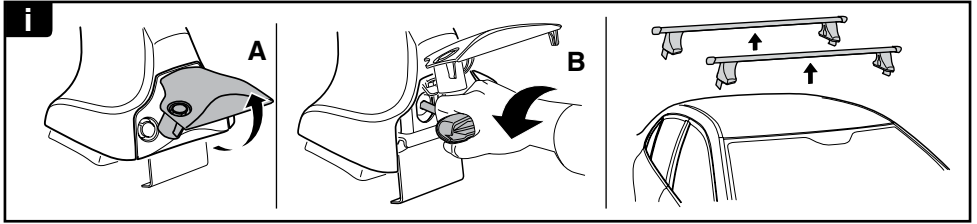

**THULE**  
SWEDEN  
**ONE  
KEY  
SYSTEM**

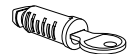
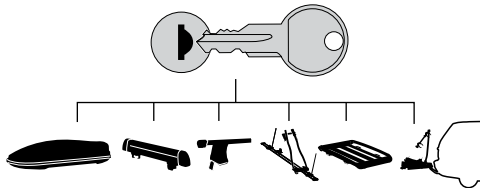

**544** (x4)

**596** (x6)

**588** (x8)

NA **510** (x10)

EUR **452** (x12)

ASIA

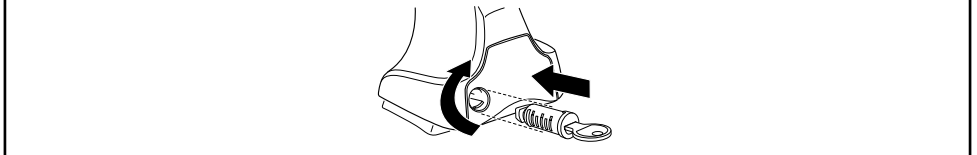

WW ▶ Thule Sweden AB, Box 69, 330 33 Hillerstorp, SWEDEN  
NA ▶ Thule Inc., 42 Silvermine Road, Seymour, Connecticut 06483, USA

info@thule.com  
customer.service@thule.com

www.thule.com

503-1689-01