

# Kit 3036

PORSCHE Cayenne, 5-dr SUV, 02-09

VOLKSWAGEN Touareg, 5-dr SUV, 02-09

This Kit is only for vehicles with T-profile.

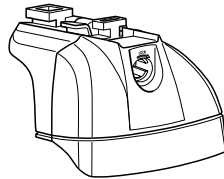

460R  
753

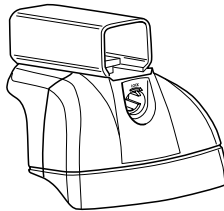

460

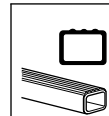

6 kg / 13 lbs + xx kg xx lbs = **Max. 100 kg**  
**Max. 220 lbs**

9 kg / 20 lbs + xx kg xx lbs = **Max. 150 kg**  
**Max. 330 lbs**

12 kg / 26 lbs + xx kg xx lbs = **Max. 200 kg**  
**Max. 440 lbs**

Warning: Do not exceed the weight limits. The weight must be distributed evenly across the roof rack.

THULE Kit XXXX

Warning: Do not exceed the recommended speed limits. The speedometer shows 80 km/h (50 Mph) and 130 km/h (80 Mph).

A. Preparing the roof surface. B. Wiping the surface. C. Attaching the roof rack.

Parts list:

- 09 x 4
- 43 x 4
- 50784 x 4
- 30154 x 4
- 51322 x 4
- 50577 x 4
- 50273 x 1

**Kit**

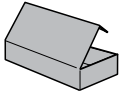

753

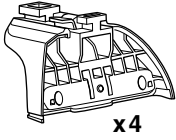

x4



x4



x4



x8

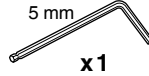

x1



x4



x1

460R

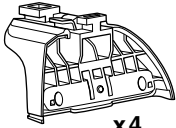

x4



x4



x4



x8

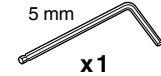

x1



x4

460

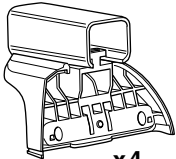

x4



x4



x4



x8

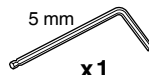

x1



x4

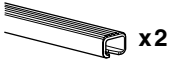
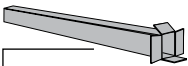

x2



x2

17 mm

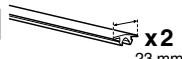

x2

23 mm



x2

23 mm

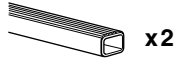

x2



x2

23 mm

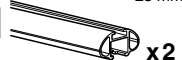

x2

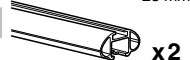

x2

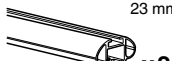

x2



x4



x4



x4

1

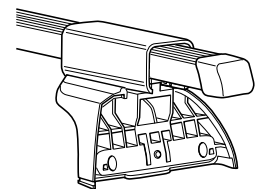
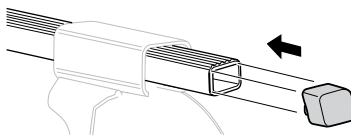
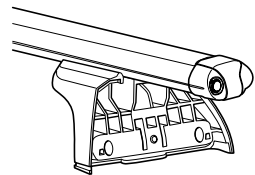
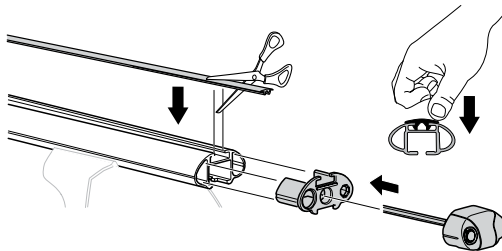
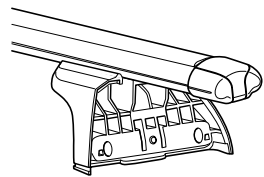
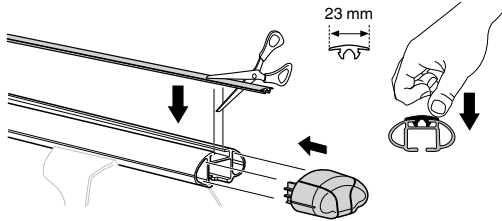
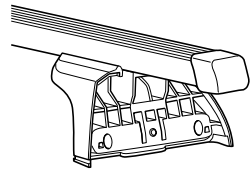
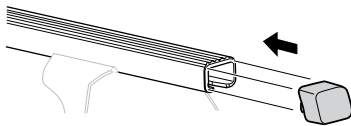
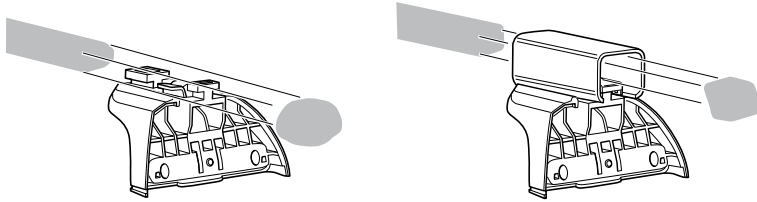
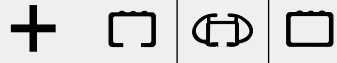
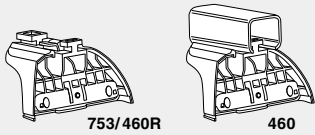

2

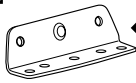

◀ 09 x 4

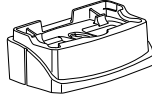

◀ 43 x 4



16 mm x 8



x 1

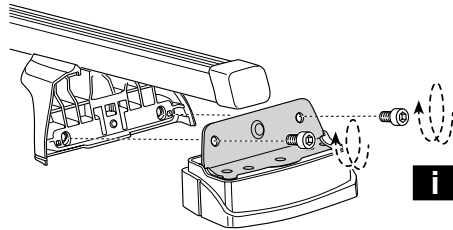
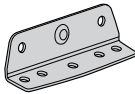
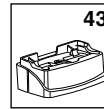
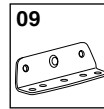
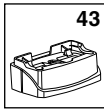
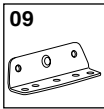
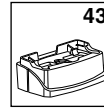
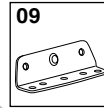
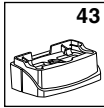
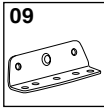

i

i

- GB** Only a few turns
- D** Nur wenige Umdrehungen
- F** Quelques tours uniquement
- NL** Slechts enkele slagen
- I** Solo qualche giro
- E** Sólo algunas vueltas
- PT** Noções básicas
- S** Endast några varv
- FIN** Vain muutama kierros

- EST** Ainult mõni pööre
- LAT** Tikai dažī apgriezieni
- LIT** Tik keli pasukimai
- PL** Wystarczy kilka obrotów
- RU** Достаточно нескольких оборотов
- CZ** Pouze několik otáčecí
- SK** Len niekoľko otáčok
- SLO** Le nekaj obratov

- HR** Samo nekoliko okreta
- HU** Csak néhány fordítás
- GR** Μόνο μερικές στροφές
- TR** Yalnız birkaç kez çevirm
- 中文** 只有几个转向
- 한국어** 두 세번만
- 日本語** 数回転のみ
- ไทย** หมุนเพียงไม่กี่รอบ

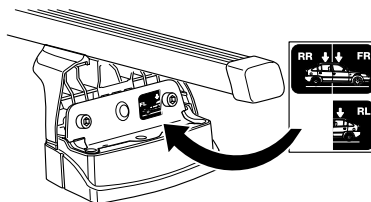

**3**

x4



x4

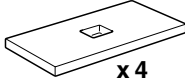

x4

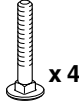

x4

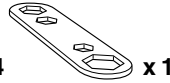

x1

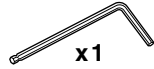

x1

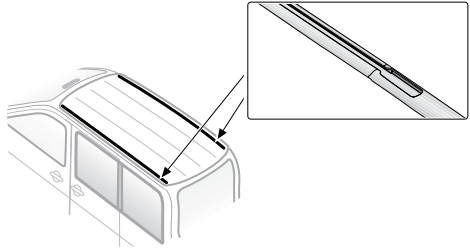
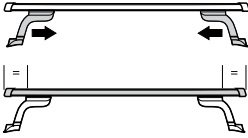

A

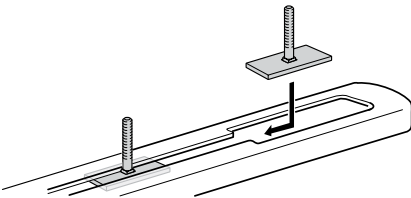
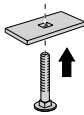
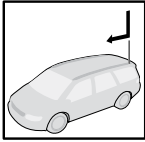

B

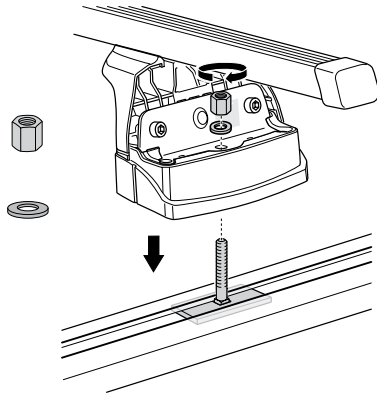

C

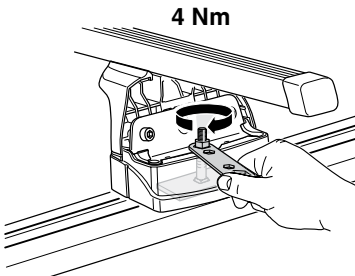

4 Nm



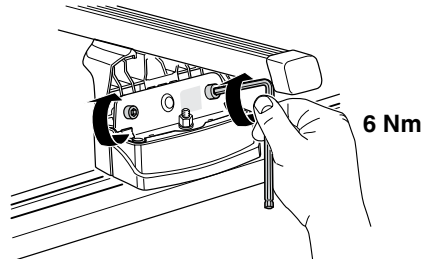

D

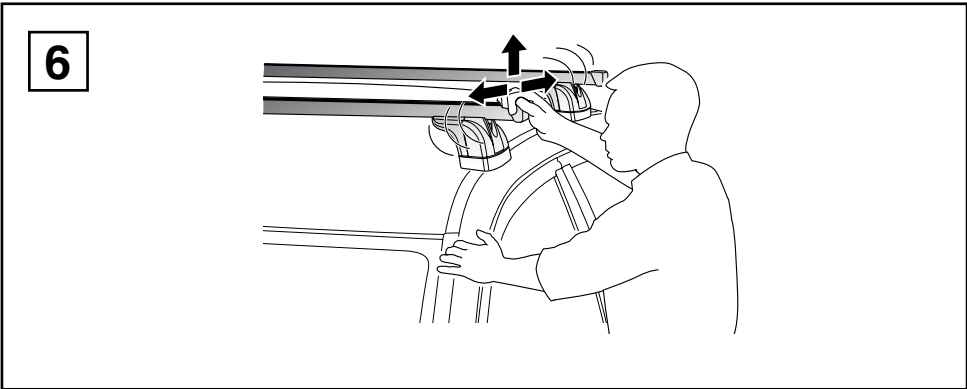
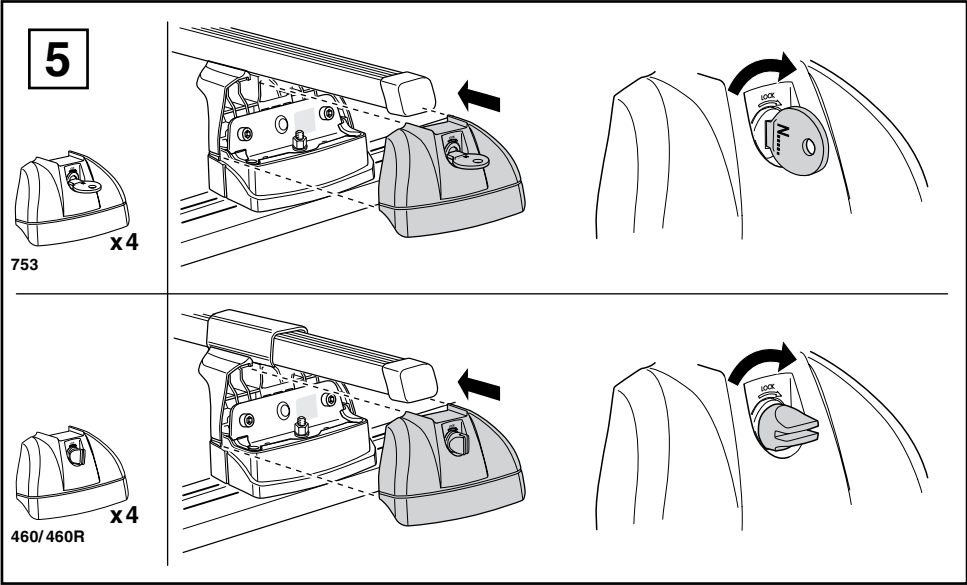
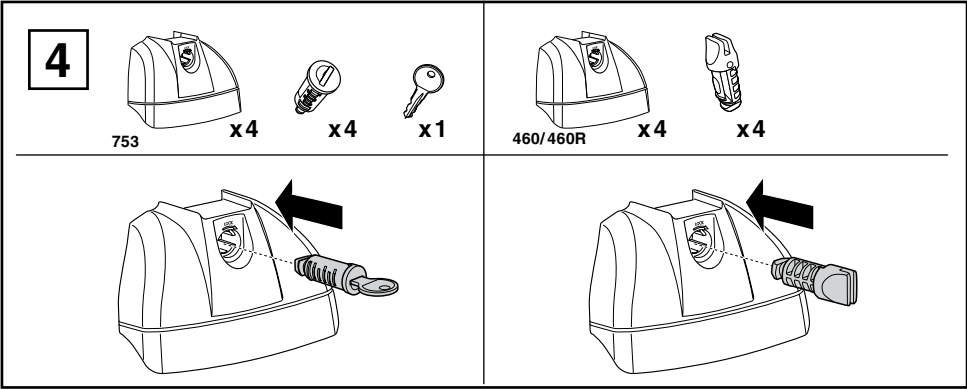

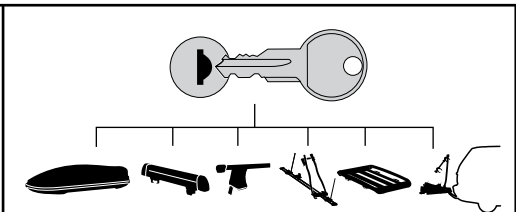
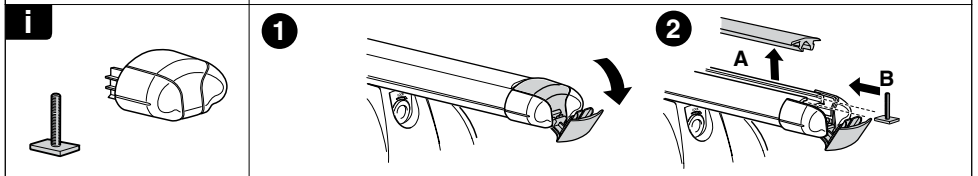
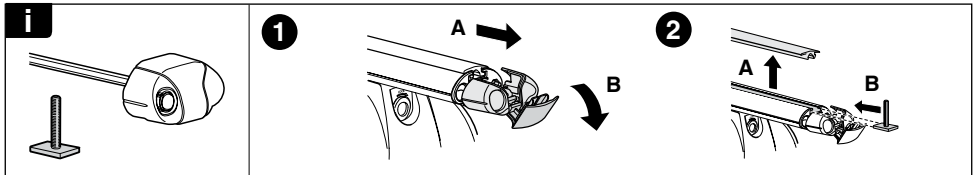
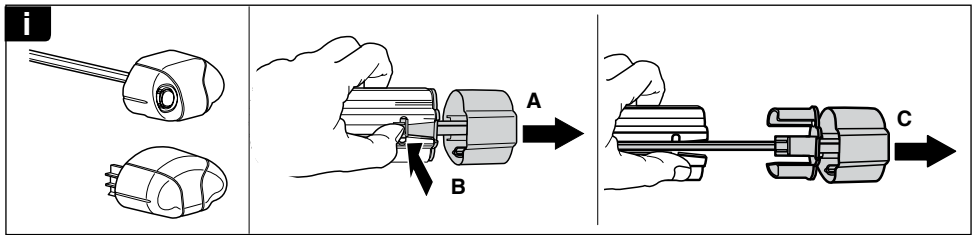
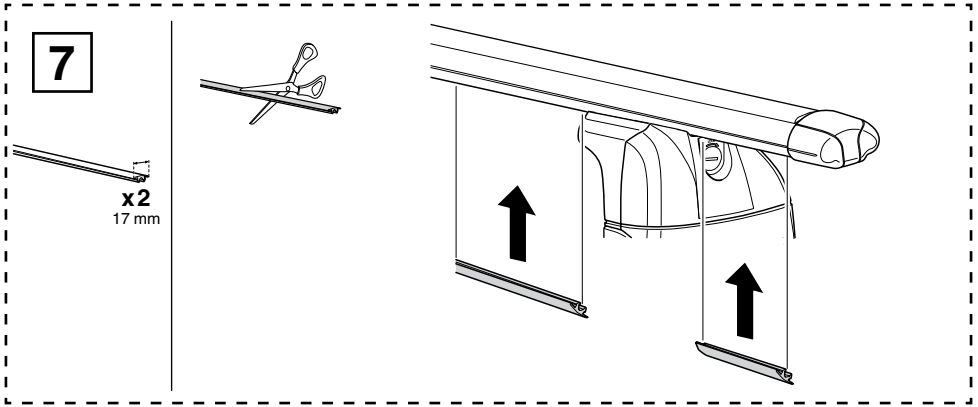
6 Nm



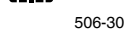

-  544 (x4)
-  596 (x6)
-  588 (x8)
-  NA 510 (x10)
-  EUR ASIA 452 (x12)

WW ▶ Thule Sweden AB, Box 69, 330 33 Hillerstorp, SWEDEN  
 NA ▶ Thule Inc., 42 Silvermine Road, Seymour, Connecticut 06483, USA

info@thule.com  
 customer.service@thule.com

 www.thule.com