

Kit 3066

MERCEDES A-Class (C169), 3-dr Hatchback, 05-
MERCEDES A-Class (W169), 5-dr Hatchback, 05-
MERCEDES B-Class (W245), 5-dr Hatchback, 05-

This Kit is only for vehicles with fixpoint mounting.

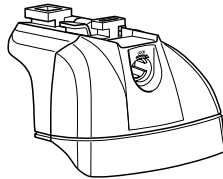

460R
753

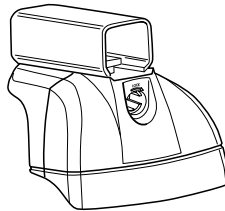

460

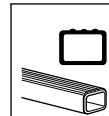

Kit

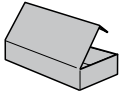

753

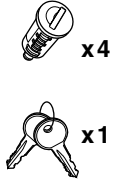
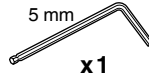
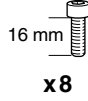
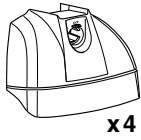
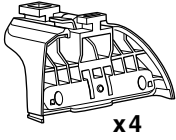

460R

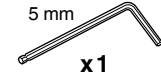
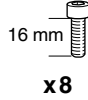
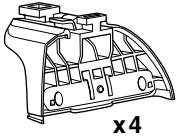

460

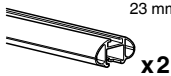
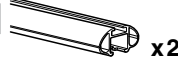
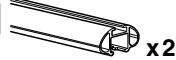
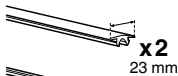
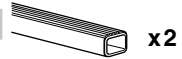
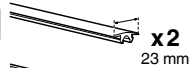
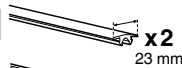
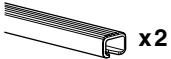
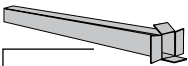
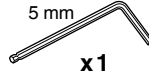
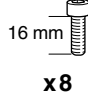
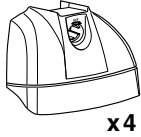
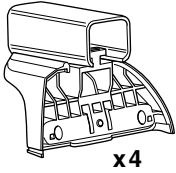

1

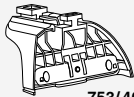

753/460R

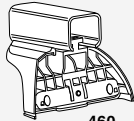

460

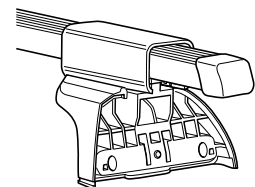
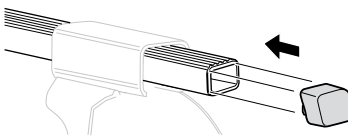
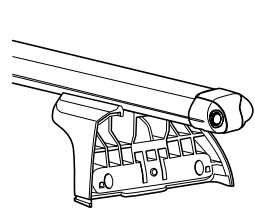
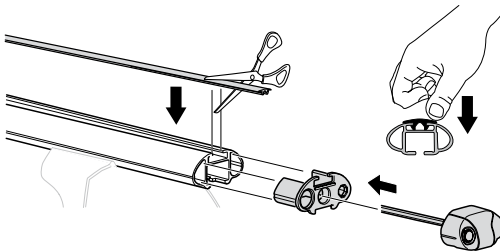
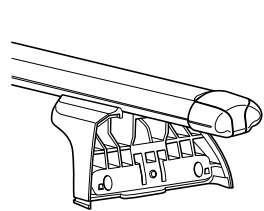
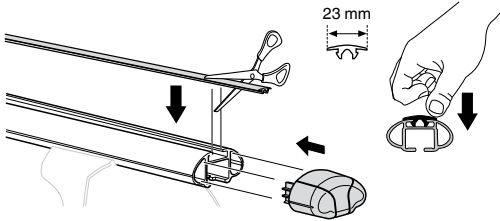
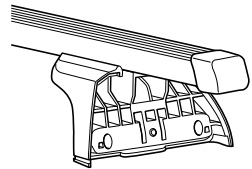
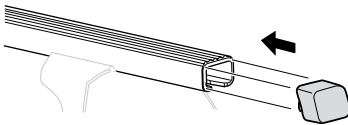
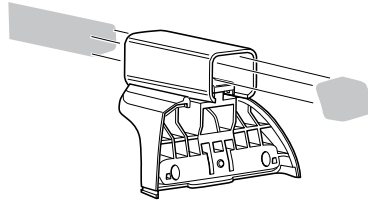
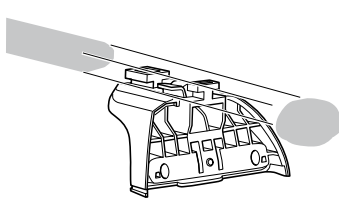

2

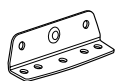

04 x 4



94 x 1



93 x 1



95 x 2

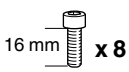

16 mm x 8

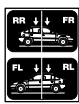

x 1

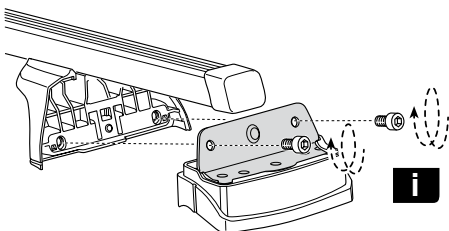
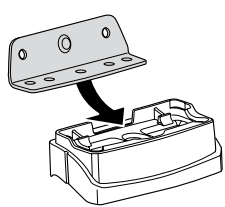
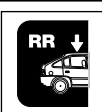
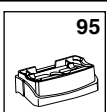
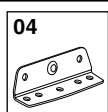
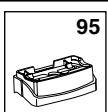
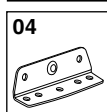
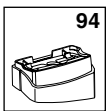
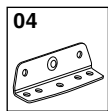
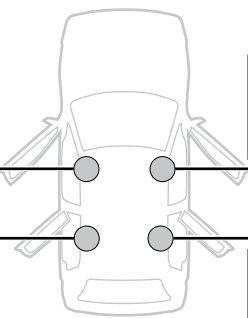
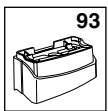
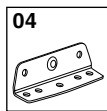

i

- GB** Only a few turns
- D** Nur wenige Umdrehungen
- F** Quelques tours uniquement
- NL** Slechts enkele slagen
- I** Solo qualche giro
- E** Sólo algunas vueltas
- PT** Noções básicas
- S** Endast några varv
- FIN** Vain muutama kierros

- EST** Ainult mõni pööre
- LAT** Tikai dažī apgriezieni
- LIT** Tik keli pasukimai
- PL** Wystarczy kilka obrotów
- RU** Достаточно нескольких оборотов
- CZ** Pouze několik otáček
- SK** Len niekoľko otáčok
- SLO** Le nekaj obratov

- HR** Samo nekoliko okreta
- HU** Csak néhány fordítás
- GR** Μόνο μερικές στροφές
- TR** Yalnız birkaç kez çevirm
- 中文** 只有几个转向
- 한국어** 두 세번만
- 日本語** 数回転のみ
- ไทย** หมุนเพียงไม่กี่รอบ

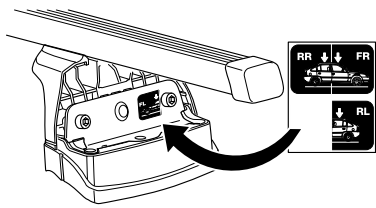

3



x 4



22 mm x 2



32 mm x 2



3 mm x 1

A

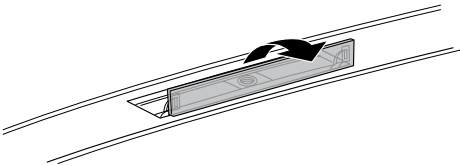
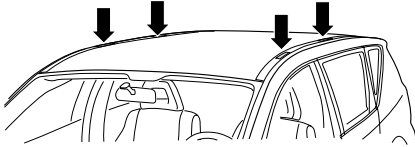

B

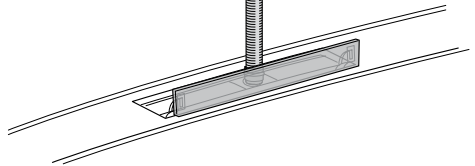
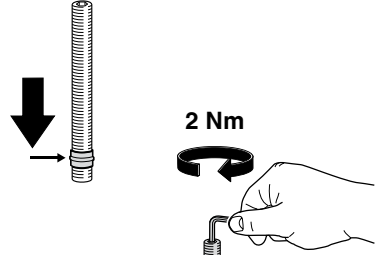

C

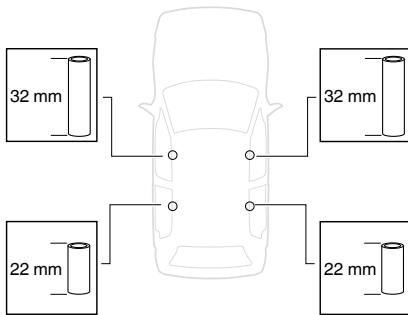

D

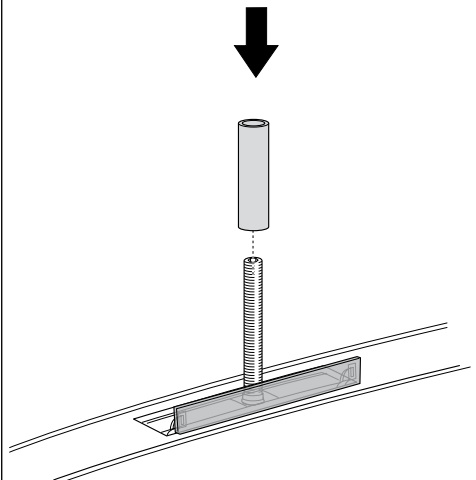

4

 x4

 x4

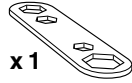
 x1

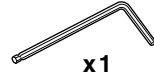
 x1

A

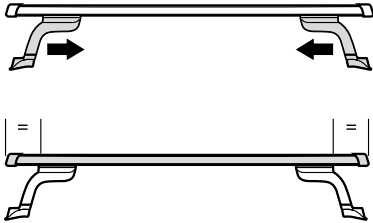

B

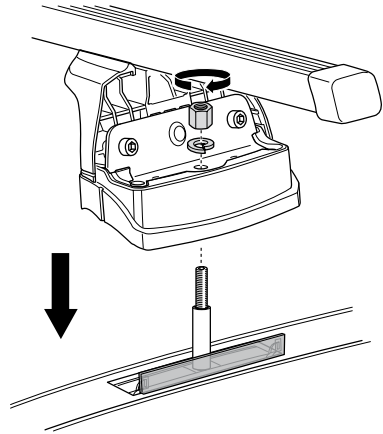

C

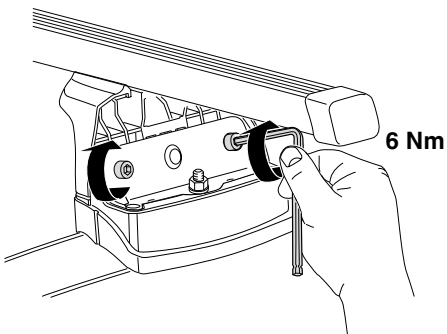

D

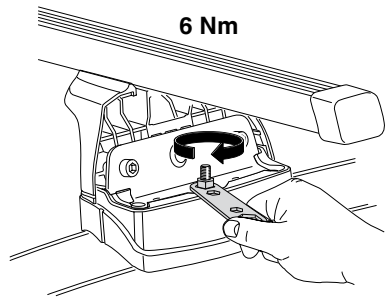

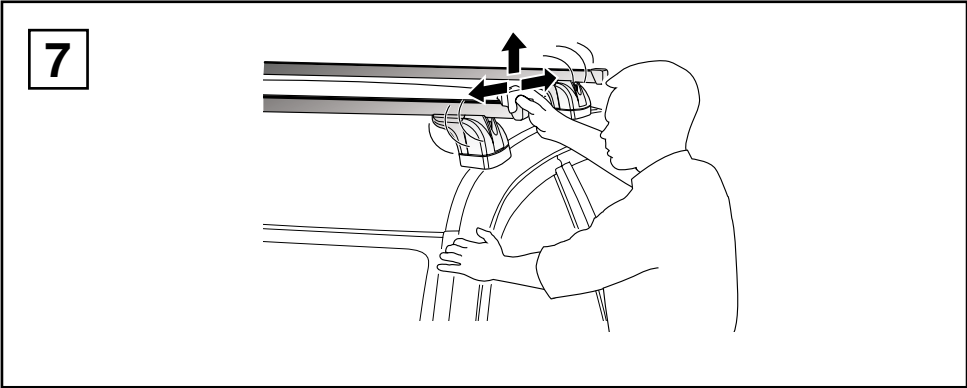
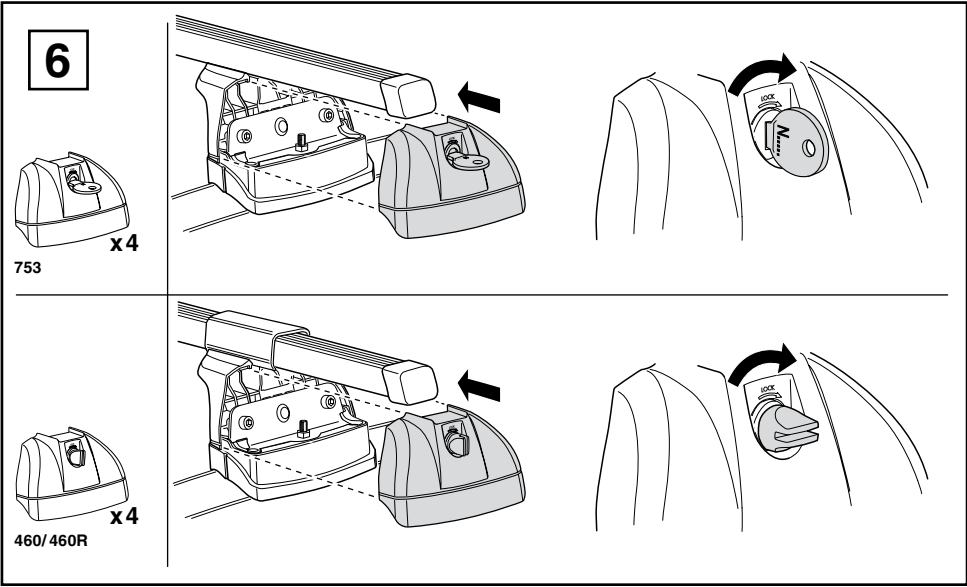
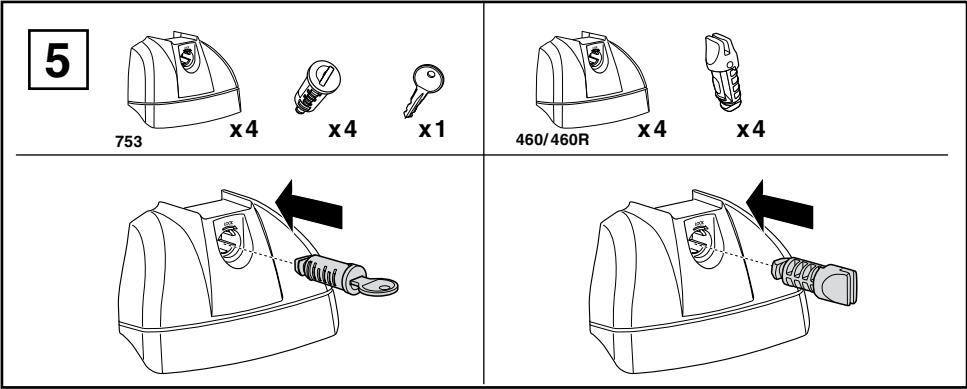

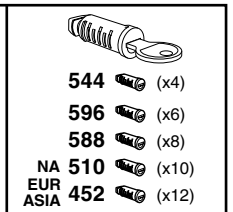
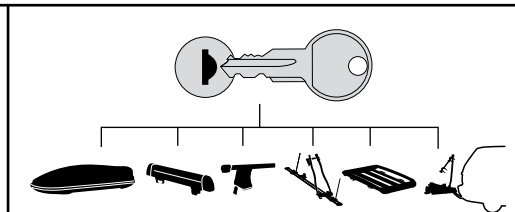
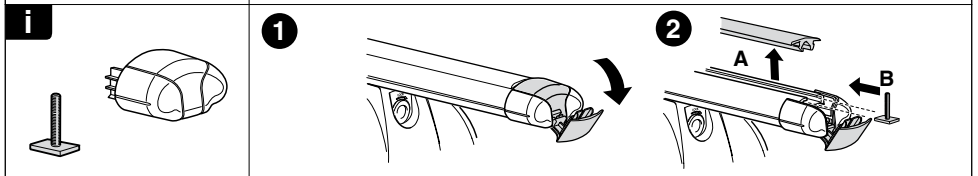
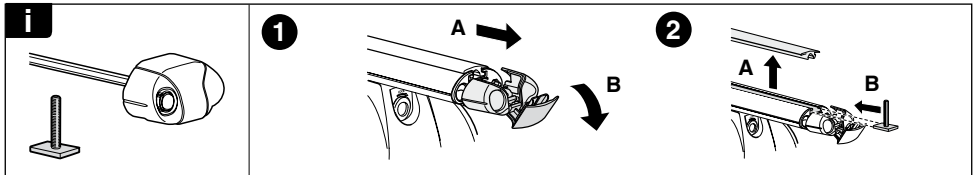
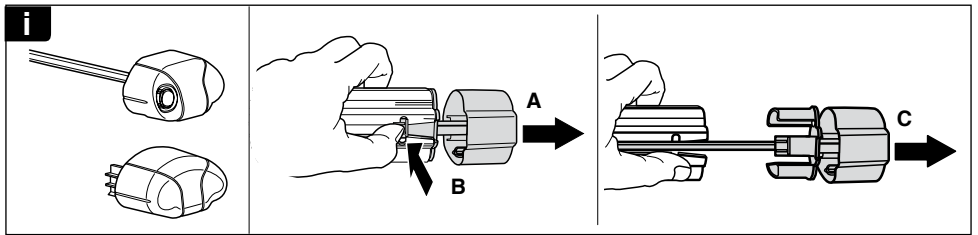
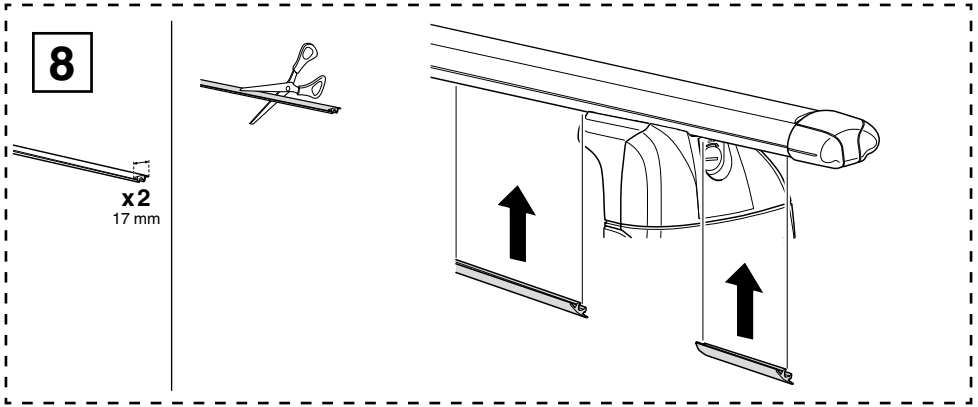

WW ▶ Thule Sweden AB, Box 69, 330 33 Hillerstorp, SWEDEN

NA ▶ Thule Inc., 42 Silvermine Road, Seymour, Connecticut 06483, USA

@ info@thule.com
customer.service@thule.com

www.thule.com