

Kit 4010

OPEL/VAUXHALL Astra, 5-dr Estate, 04-06

OPEL/VAUXHALL Signum, 5-dr Estate, 03-08

OPEL/VAUXHALL Vectra, 5-dr Estate, 03-04, 05-08

OPEL/VAUXHALL/HOLDEN Zafira, 5-dr MPV, 05-06

This kit is only for vehicles with flush or integrated side railing.

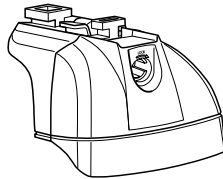

**460R
753**

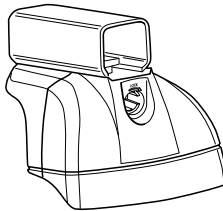

460

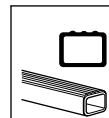

Kit



753



x4



x4



x4



16 mm

x8

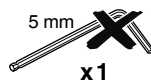

5 mm

x1



x4



x1

460R

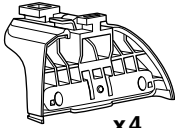

x4



x4



x4



16 mm

x8

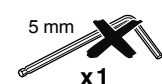

5 mm

x1



x4

460

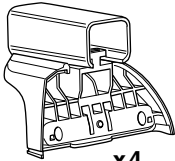

x4



x4



x4



16 mm

x8

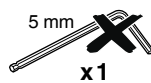

5 mm

x1



x4

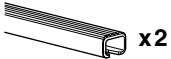

x2



x2

23 mm



x1

17 mm



x2

23 mm

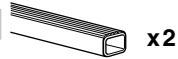

x2

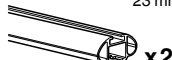

x2

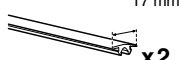

x2

23 mm

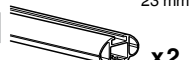

x2



x4

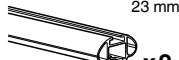

x2



x4



x4

1



753/460R



460

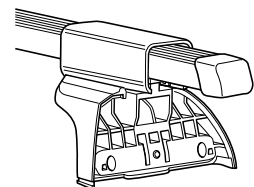
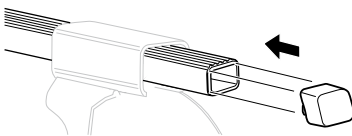
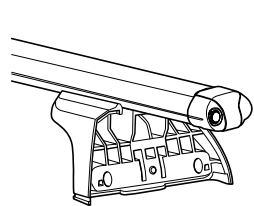
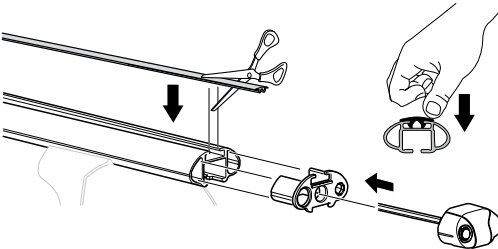
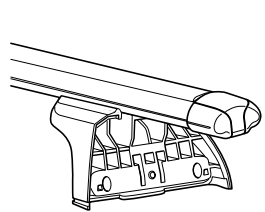
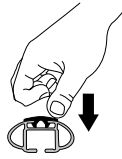
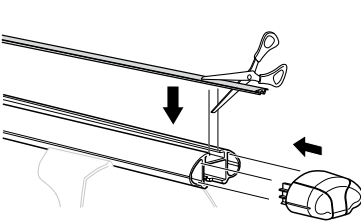
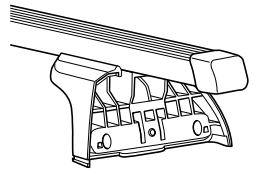
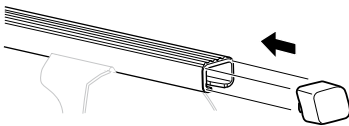
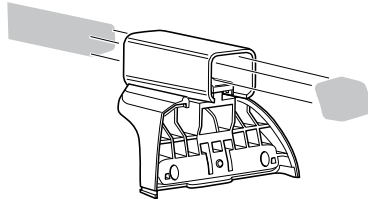
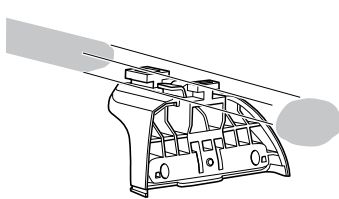

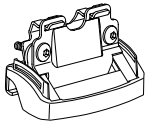
2**x 4**

i	GB Only a few turns	EST Ainult mõni pööre	HR Samo nekoliko okreta
	D Nur wenige Umdrehungen	LAT Tikai dažī apgriezieni	HU Csak néhány fordítás
	F Quelques tours uniquement	LIT Tik keli pasukimai	GR Μόνο μερικές στροφές
	NL Slechts enkele slagen	PL Wystarczy kilka obrotów	TR Yalnız birkaç kez çevirm
	I Solo qualche giro	RU Достаточно нескольких оборотов	中文 只有几个转向
	E Sólo algunas vueltas	CZ Pouze několik otáček	한국어 두 세번만
	PT Noções básicas	SK Len niekoľko otáčok	日本語 数回転のみ
	S Endast några varv	SLO Le nekaj obratov	ไทย หมุนเพียงไม่กี่รอบ
	FIN Vain muutama kierros		

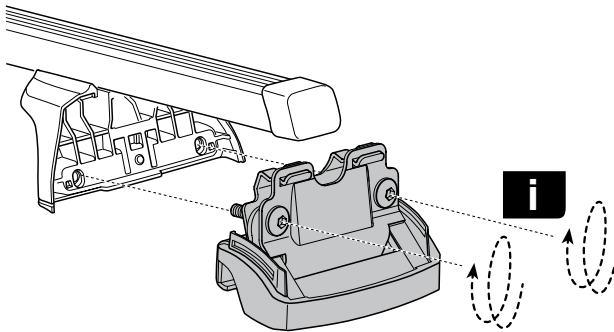
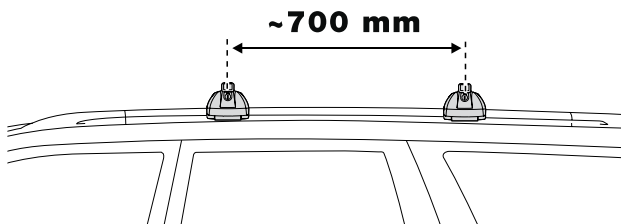
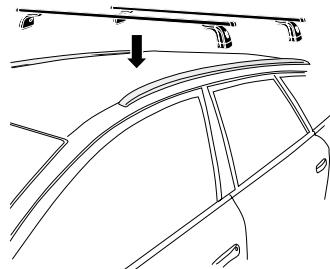
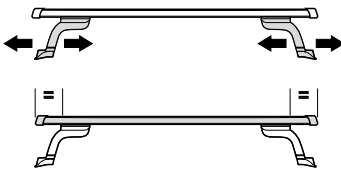
**3**

4

A

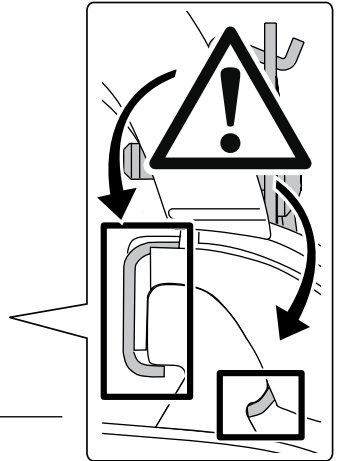
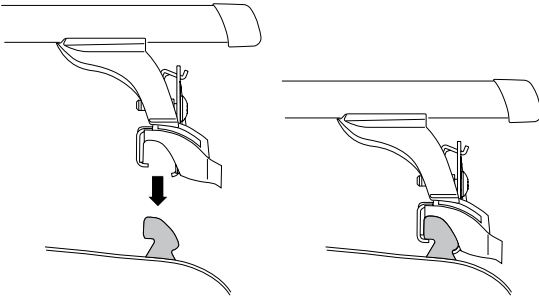

B

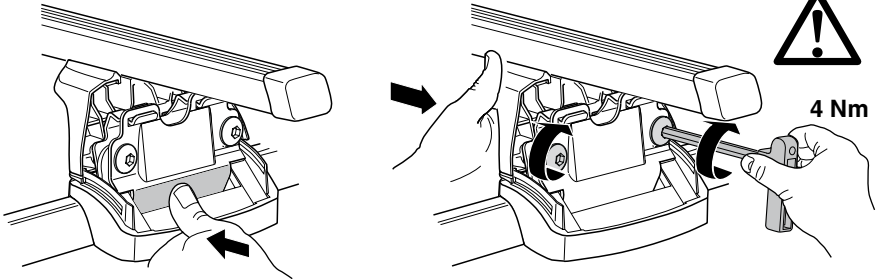
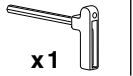

GB/US
D
F
NL
I
E
PT
S
FIN
EST
LAT
LIT
PL
RU

Tighten alternately
Die Schrauben abwechselnd anziehen
Serrer alternativement chaque côté
Afwisselend aan de linker- en de rechterkant aandraaien
Alternare il serraggio delle viti
Apretar alternativamente
Aperte alternadamente
Dra åt växelvis
Kierrä vuorotellen
Pinguldage vaheldumisi
Pievelciēt pamišus
Užsukinėkite pakaitomis
Śruby dokręcaj naprzemiennie
Затягивайте попеременно

CZ
SK
SLO
HR
HU
GR
TR
中文
한국어
日本語
ไทย

Pokreťta bagažnika dokręcaj dokręcaj naprzemiennie.
Dotahujte striedavo
Privijajte izmenično.
Naizmjениčno zategnite
Egymástól függetlenül szorítandó
Σφιγγετε εναλλάξ
Dönüşümlü sıkın
交替拧紧
번갈아 가며 조이십시오.
交互に締め付けてください。
ชิ้นในแบบสลับ



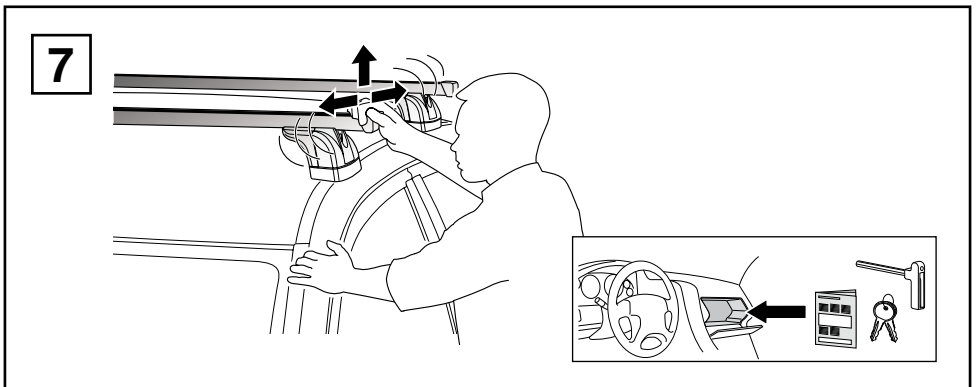
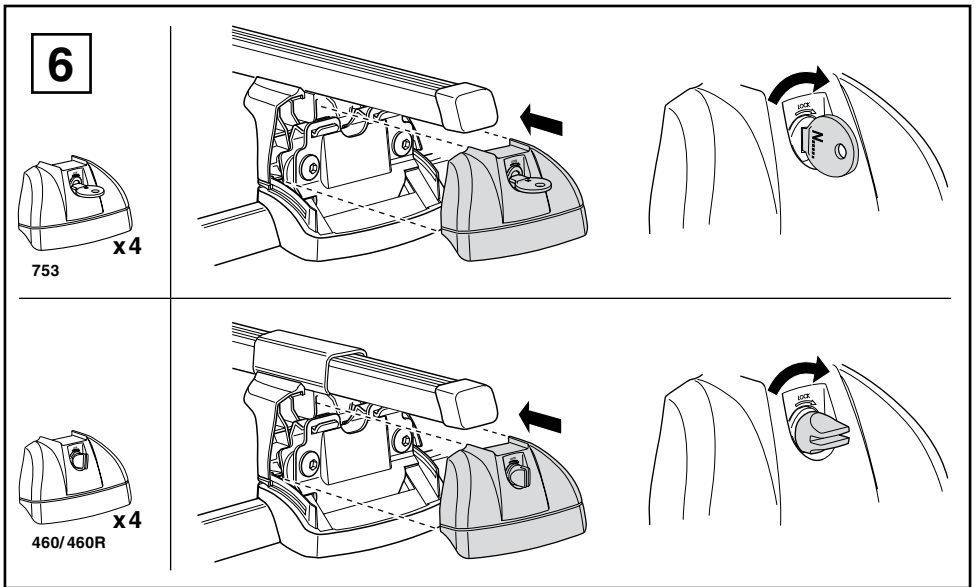
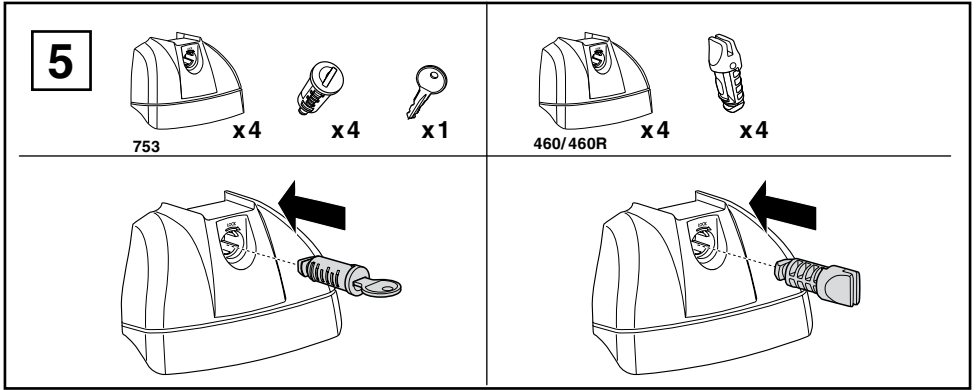

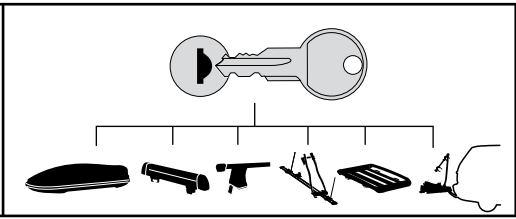
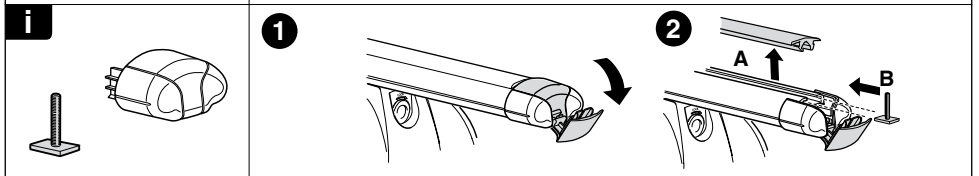
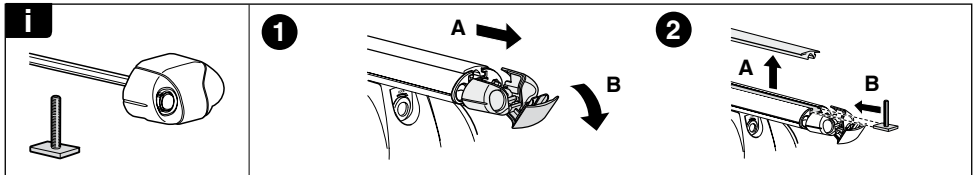
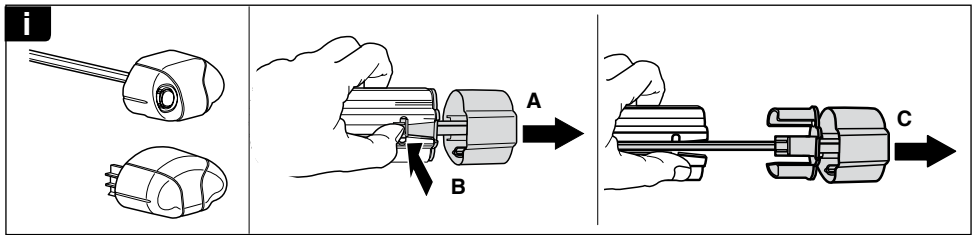
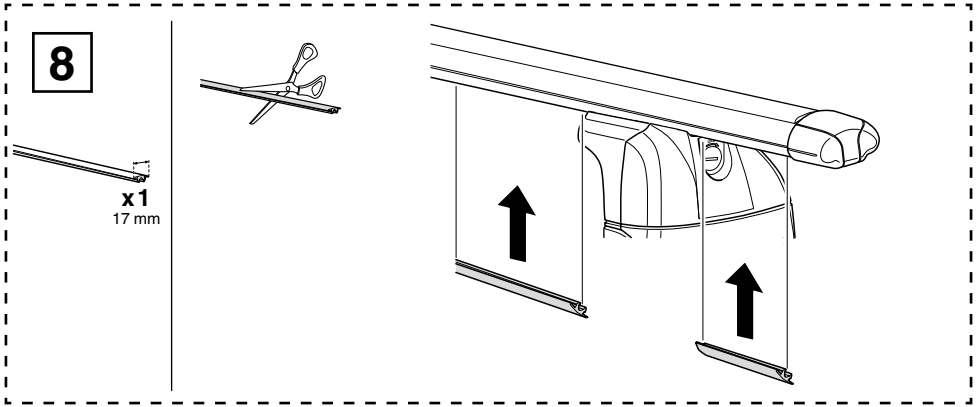

- 544 (x4)
- 596 (x6)
- 588 (x8)
- NA 510 (x10)
- EUR 452 (x12)

WW Thule Sweden AB, Box 69, 330 33 Hillerstorp, SWEDEN
 NA Thule Inc., 42 Silvermine Road, Seymour, Connecticut 06483, USA

info@thule.com
 customer.service@thule.com

www.thule.com