

Kit 4011

OPEL/VAUXHALL/HOLDEN Astra, 5-dr Estate, 07-
OPEL/VAUXHALL/HOLDEN Zafira, 5-dr MPV, 07-11

This kit is only for vehicles with flush or integrated side railing.



460R
753

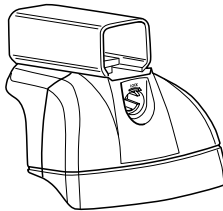

460

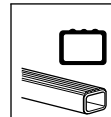

Kit

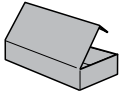

753

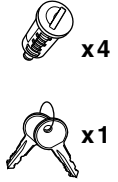
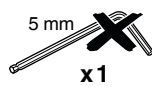
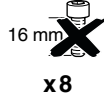
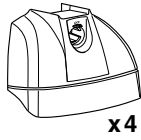
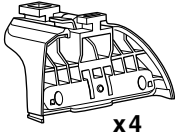

460R

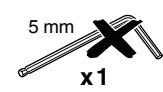
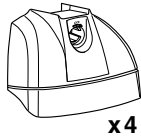
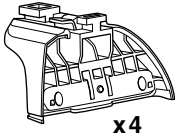

460

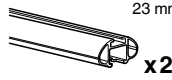
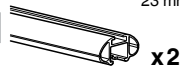
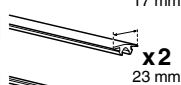
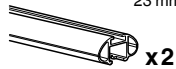
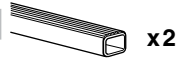
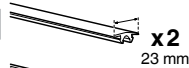
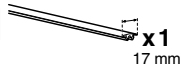
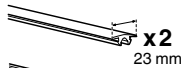
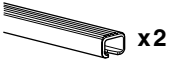
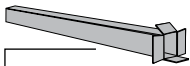
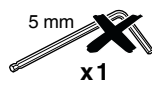
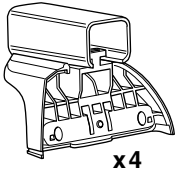

1

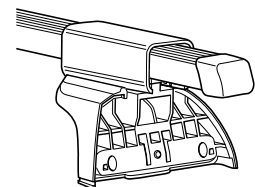
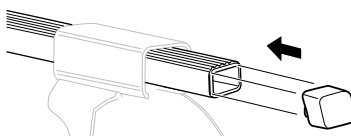
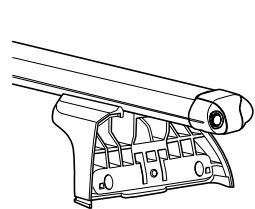
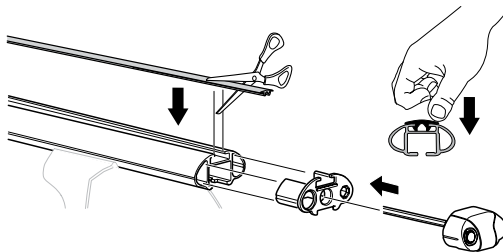
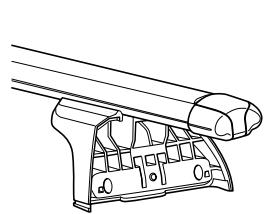
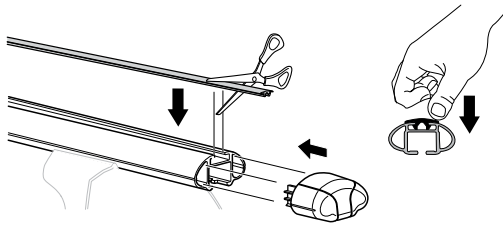
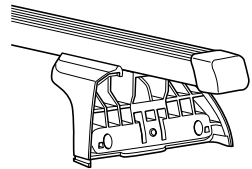
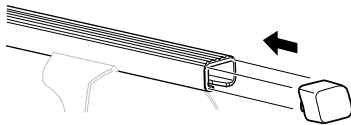
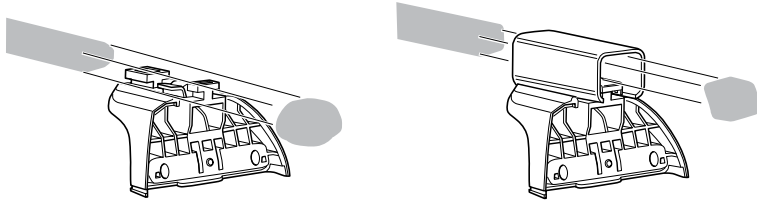
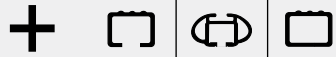
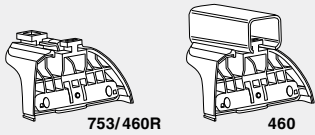

2**x 4****i**

GB	Only a few turns	EST	Ainult mõni pööre	HR	Samo nekoliko okreta
D	Nur wenige Umdrehungen	LAT	Tikai dažī apgriezieni	HU	Csak néhány fordítás
F	Quelques tours uniquement	LIT	Tik keli pasukimai	GR	Μόνο μερικές στροφές
NL	Slechts enkele slagen	PL	Wystarczy kilka obrotów	TR	Yalnız birkaç kez çevirm
I	Solo qualche giro	RU	Достаточно нескольких оборотов	中文	只有几个转向
E	Sólo algunas vueltas	CZ	Pouze několik otáček	한국어	두 세번만
PT	Noções básicas	SK	Len niekoľko otáčok	日本語	数回転のみ
S	Endast några varv	SLO	Le nekaj obratov	ไทย	หมุนเพียงไม่กี่รอบ
FIN	Vain muutama kierros				

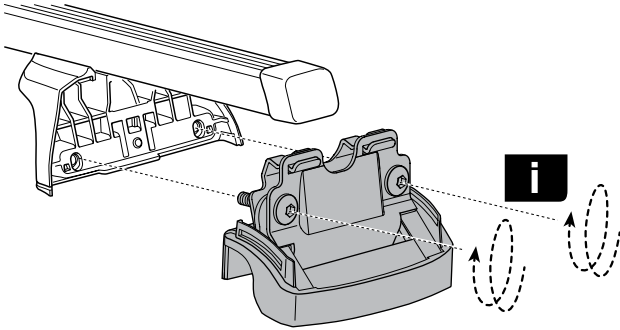
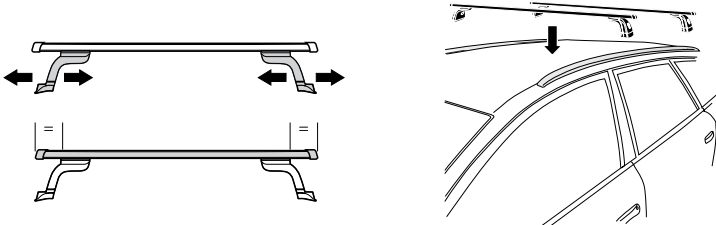
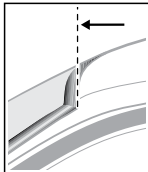
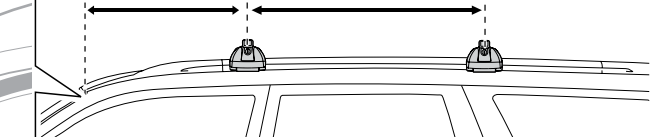
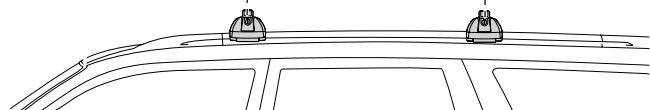
**3****Astra****430 mm****700 mm****~700 mm****Zafira**

4

A

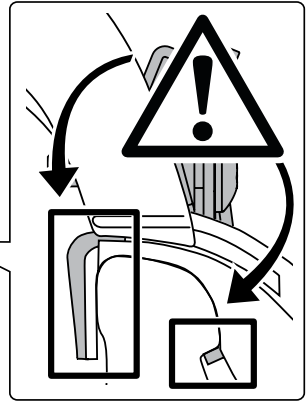
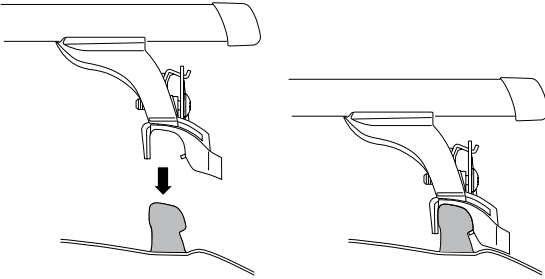

B

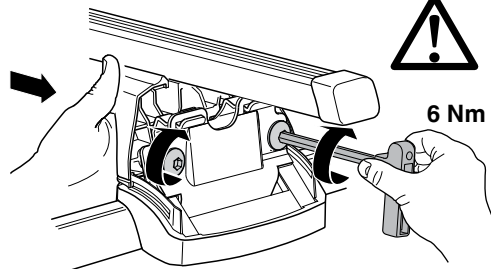
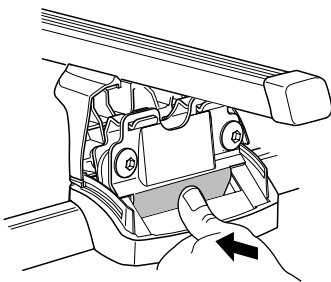
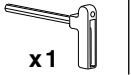

GB/US
D
F
NL
I
E
PT
S
FIN
EST
LAT
LIT
PL
RU

Tighten alternately
Die Schrauben abwechselnd anziehen
Serrer alternativement chaque côté
Afwisselend aan de linker- en de rechterkant aandraaien
Alternare il serraggio delle viti
Apretar alternativamente
Aperte alternadamente
Dra åt växelvis
Kierrä vuorotellen
Pinguldage vaheldumisi
Pievelciēt pamīšus
Užsukinėkite pakaitomis
Śruby dokręcaj naprzemiennie
Затягивайте попеременно

CZ
SK
SLO
HR
HU
GR
TR
中文
한국어
日本語
ไทย

Pokrétla bagažnika dokręcaj dokręcaj naprzemiennie.
Dotahujte striedavo
Privijajte izmenično.
Naizmjenično zategnite
Egymástól függetlenül szorítandó
Σφιγγετε εναλλάξ
Dönüşümlü sıkın
交替拧紧
번갈아 가며 조이십시오.
交互に締め付けてください。
ขึ้นในแบบสลับ



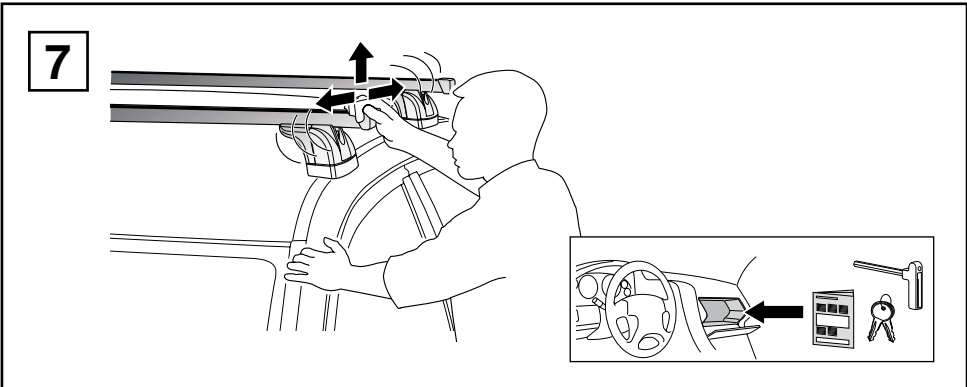
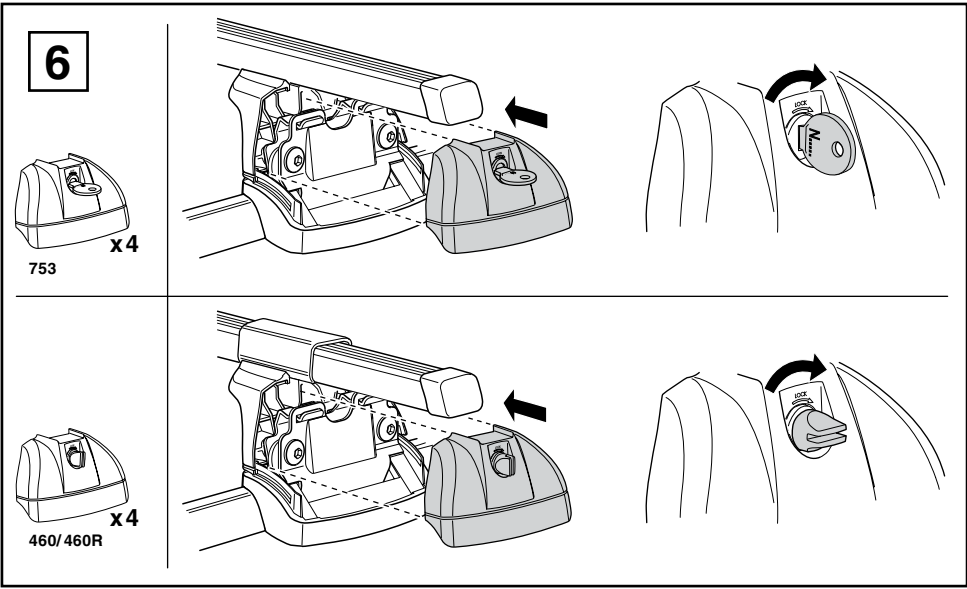
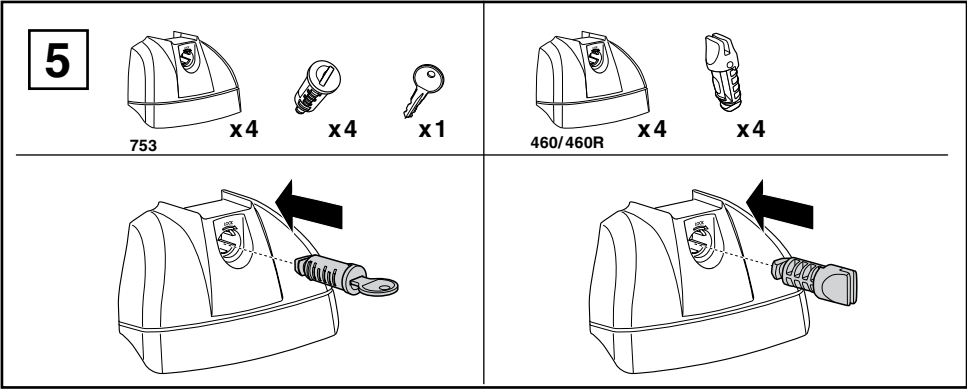

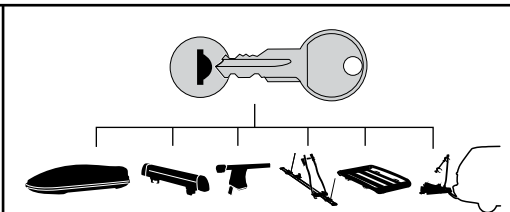
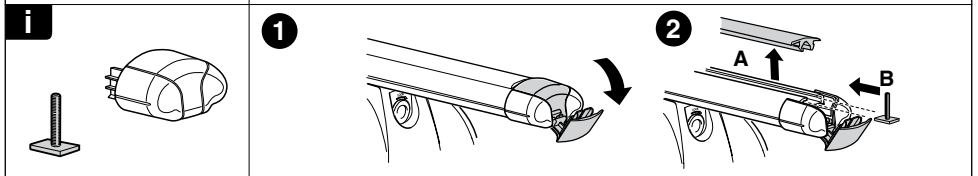
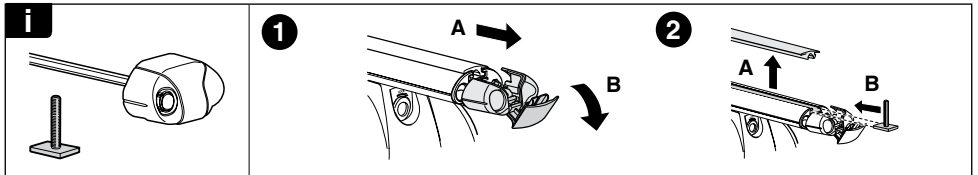
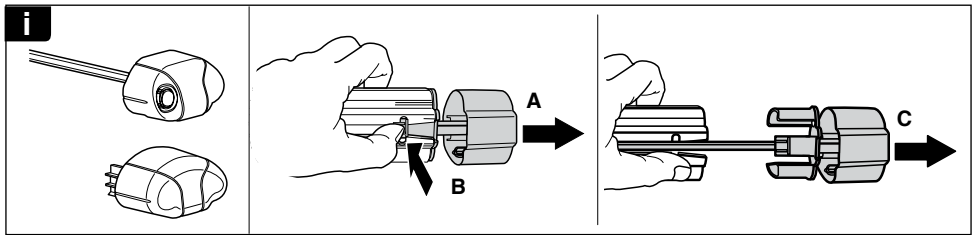
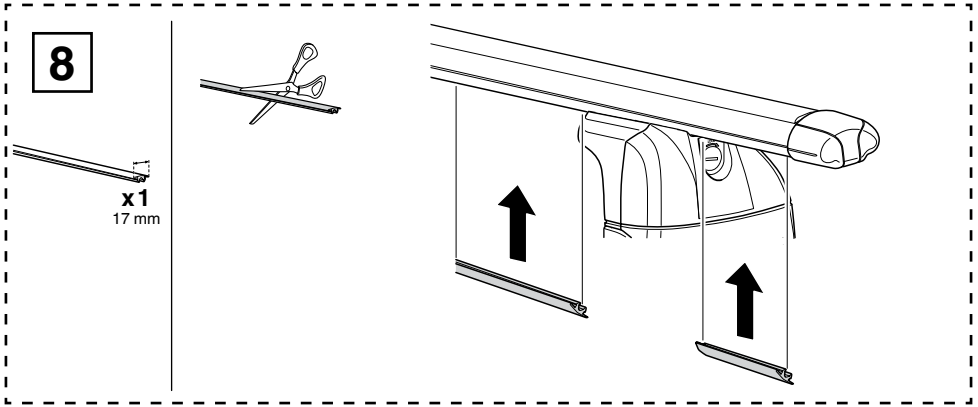

- 544 (x4)
- 596 (x6)
- 588 (x8)
- NA 510 (x10)
- EUR 452 (x12)

WW ▶ Thule Sweden AB, Box 69, 330 33 Hillerstorp, SWEDEN
 NA ▶ Thule Inc., 42 Silvermine Road, Seymour, Connecticut 06483, USA

info@thule.com
 customer.service@thule.com

www.thule.com

506-4011-03