

Kit 4030

MITSUBISHI Outlander, 5-dr SUV, 13-

This kit is only for vehicles with flush or integrated side railing.

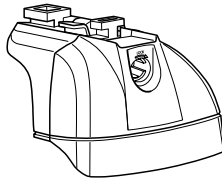

460R
753

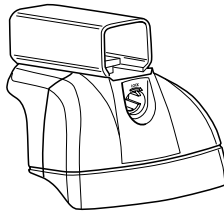

460

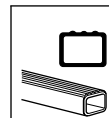

Kit

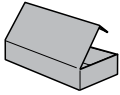

753

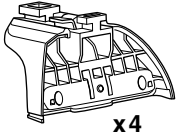

x4



x4



x4



16 mm

x8

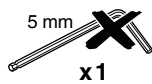

5 mm

x1



x4



x1

460R

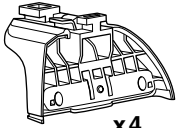

x4



x4



x4



16 mm

x8

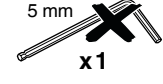

5 mm

x1



x4

460

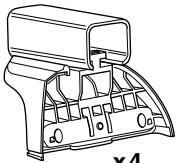

x4



x4



x4



16 mm

x8

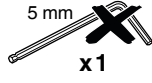

5 mm

x1



x4

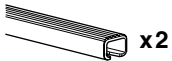
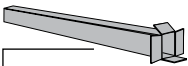

x2



x2

23 mm



x1

17 mm



x2

23 mm

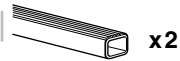

x2

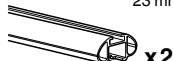

x2

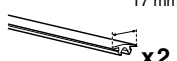

x2

23 mm

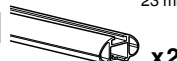

x2



x4

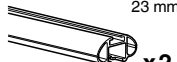

x2



x4



x4

1

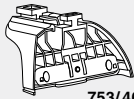

753/460R

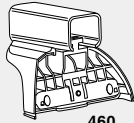

460

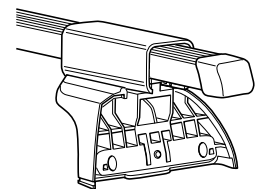
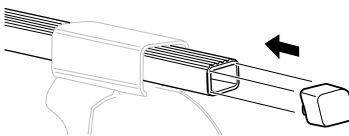
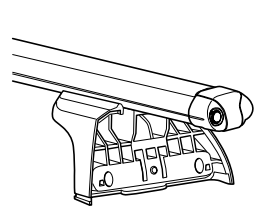
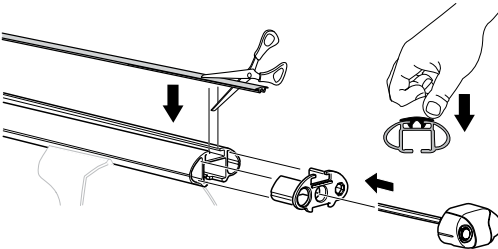
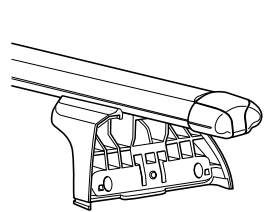
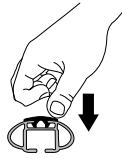
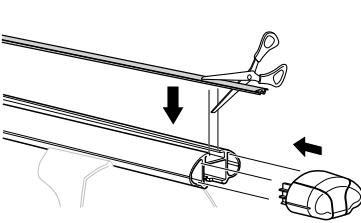
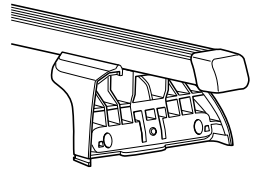
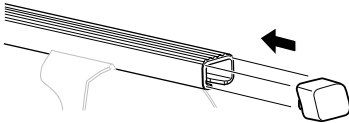
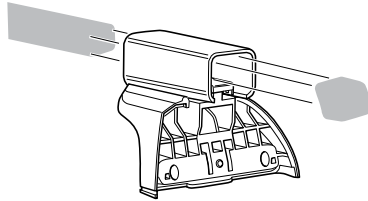
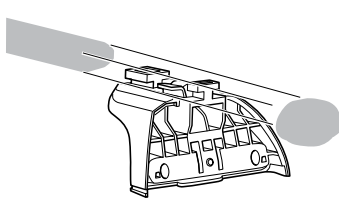

2**x 4**

| | | | |
|----------|------------------------------------|--|------------------------------------|
| i | GB Only a few turns | EST Ainult mõni pööre | HR Samo nekoliko okreta |
| | D Nur wenige Umdrehungen | LAT Tikai dažī apgriezieni | HU Csak néhány fordítás |
| | F Quelques tours uniquement | LIT Tik keli pasukimai | GR Μόνο μερικές στροφές |
| | NL Slechts enkele slagen | PL Wystarczy kilka obrotów | TR Yalnız birkaç kez çevirm |
| | I Solo qualche giro | RU Достаточно нескольких оборотов | 中文 只有几个转向 |
| | E Sólo algunas vueltas | CZ Pouze několik otáček | 한국어 두 세번만 |
| | PT Noções básicas | SK Len niekoľko otáčok | 日本語 数回転のみ |
| | S Endast några varv | SLO Le nekaj obratov | ไทย หมุนเพียงไม่กี่รอบ |
| | FIN Vain muutama kierros | | |

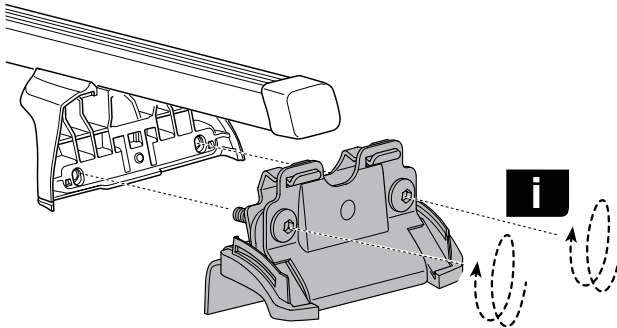
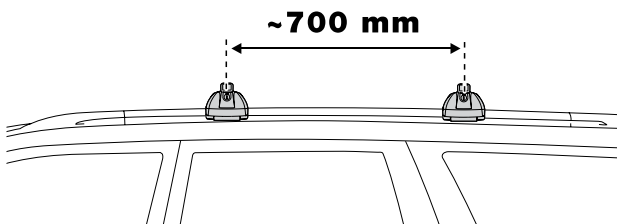
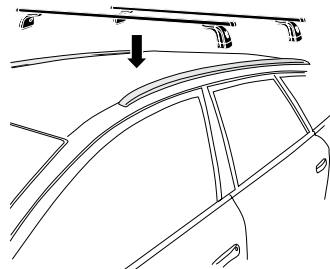
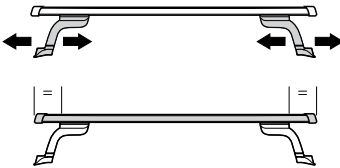
**3**

4

A

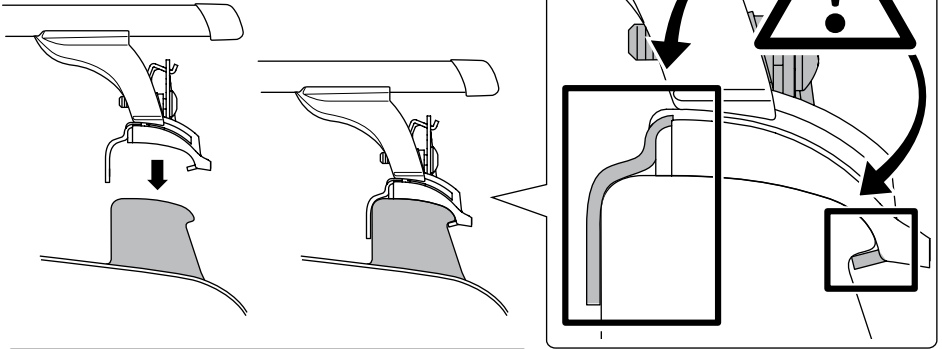

B

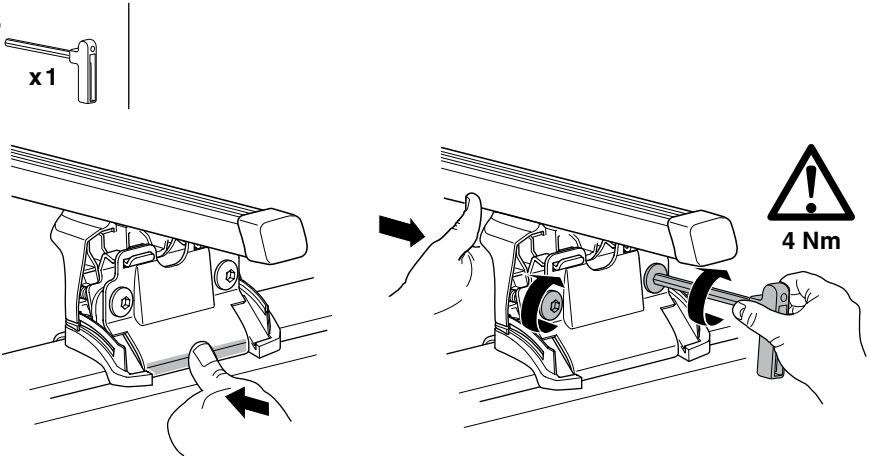

GB/US Tighten alternately
D Die Schrauben abwechselnd anziehen
F Serrer alternativement chaque côté
NL Afwisselend aan de linker- en de rechterkant aandraaien
I Alternare il serraggio delle viti
E Apretar alternativamente
PT Aperte alternadamente
S Dra åt växelvis
FIN Kierrä vuorotellen
EST Pinguldage vaheldumisi
LAT Pīvelciēt pamišus
LIT Užsukinėkite pakaitomis
PL Śruby dokręcaj naprzemiennie
RU Затягивайте попеременно

CZ Pokręta багаžnika dokręcaj dokręcaj naprzemiennie.
SK Dotahujte striedavo
SLO Privijajte izmenično.
HR Naizmjenočno zategnite
HU Egymástól függetlenül szorítandó
GR Σφιγγεται εναλλάξ
TR Dönüşümlü sıkın
中文 交替拧紧
한국어 번갈아 가며 조이십시오.
日本語 交互に締め付けてください。
ไทย ซึนในแบบสลับ



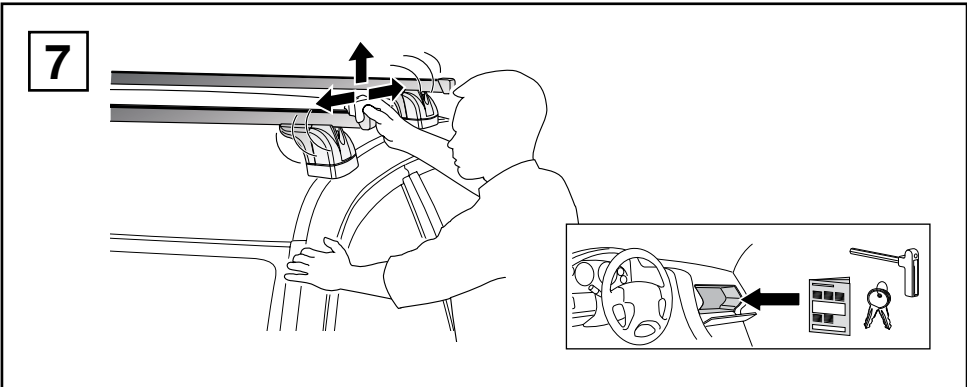
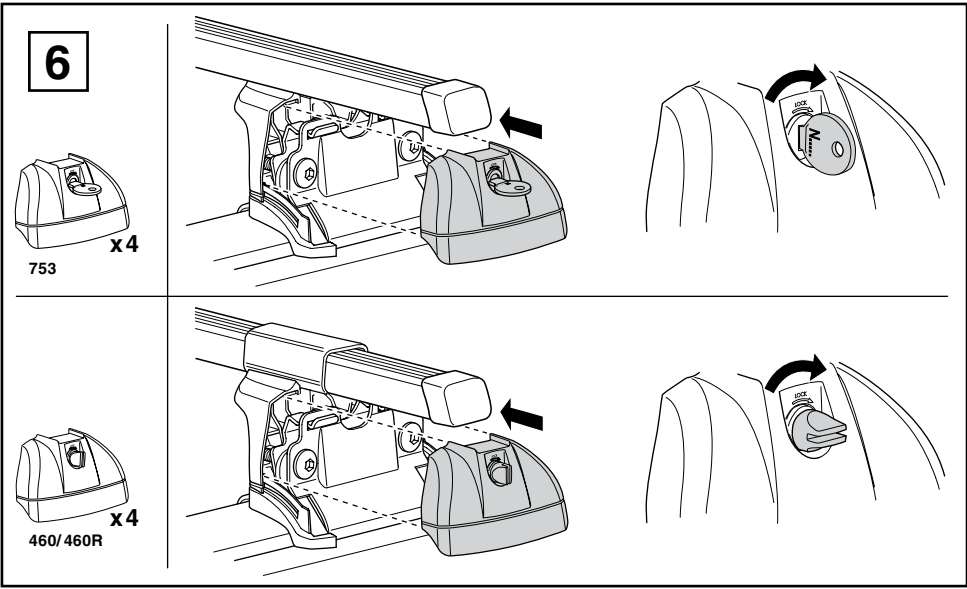
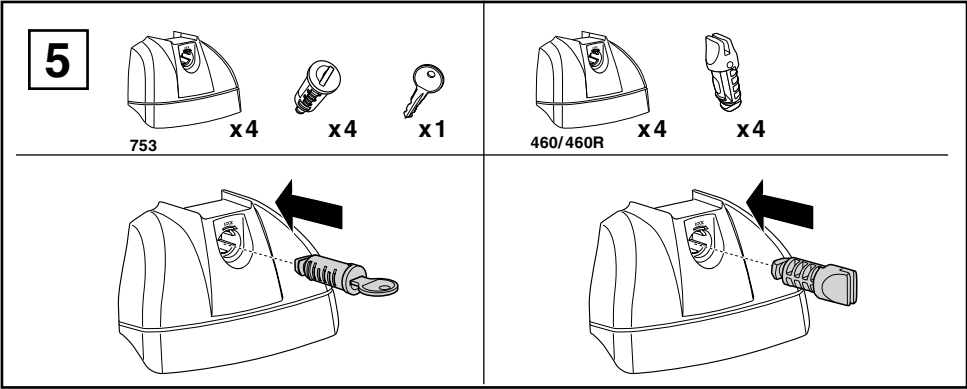

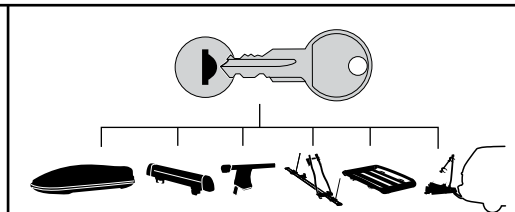
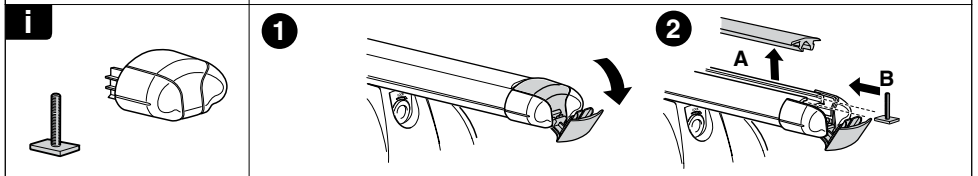
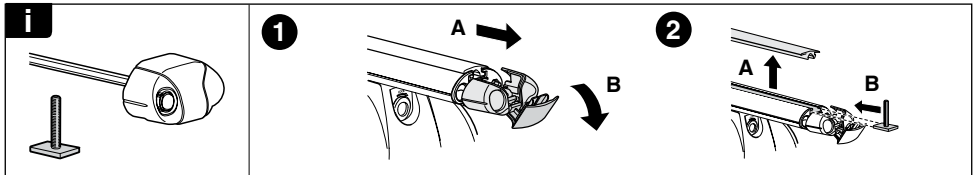
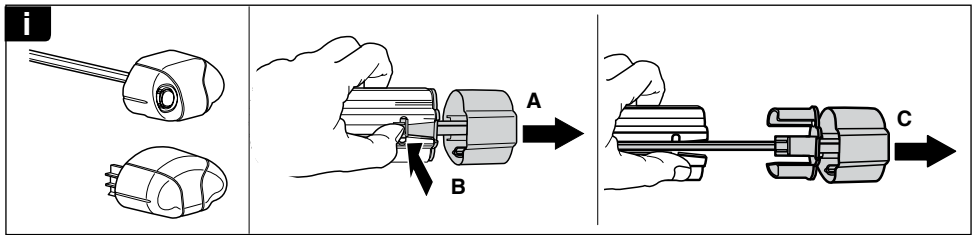
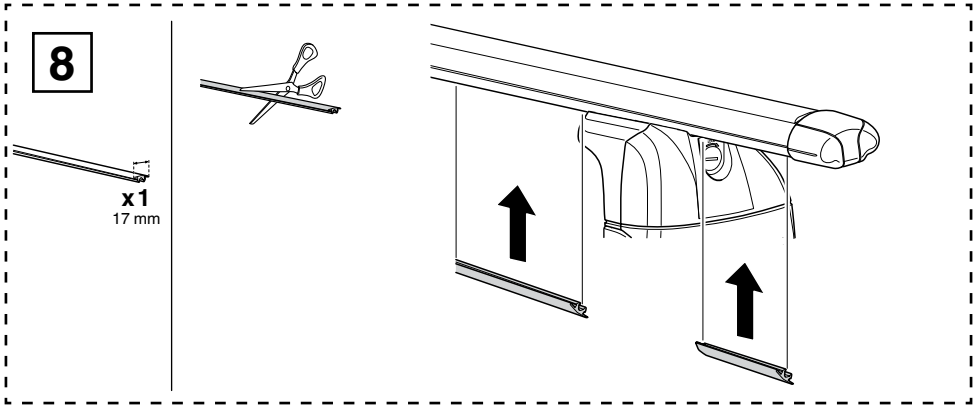

- 544 (x4)
- 596 (x6)
- 588 (x8)
- NA 510 (x10)
- EUR 452 (x12)

WW ▶ Thule Sweden AB, Box 69, 330 33 Hillerstorp, SWEDEN
 NA ▶ Thule Inc., 42 Silvermine Road, Seymour, Connecticut 06483, USA

info@thule.com
 customer.service@thule.com

www.thule.com

506-4030-01