

Kit 4022

BMW 5-Series Touring, 5-dr Estate, 10-

This kit is only for vehicles with flush or integrated side railing.

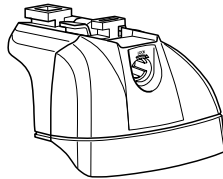

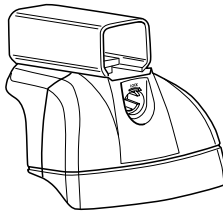

460R
753



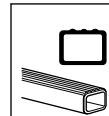



460





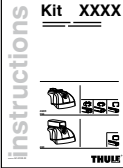

 + 
 = **Max. 75kg**
Max. 165 lbs

5 kg
 11 lbs





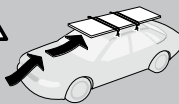

 + 

Kit XXXX
 instructions
 THULE



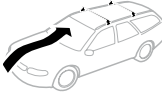

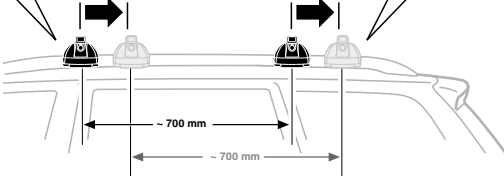
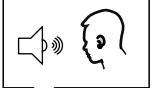

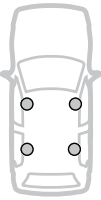

80 km/h
 50 Mph
 130 km/h
 80 Mph
 40 km/h
 25 Mph
km/h
Mph

~ 700 mm
 ~ 700 mm

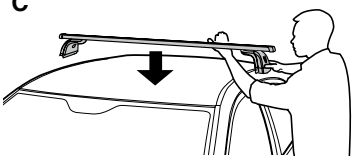
A **B** **C**

30349
x 1

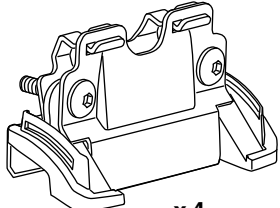
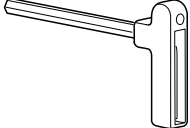
x 4 **x 1**

Kit

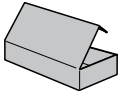

753

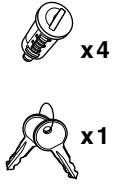
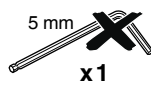
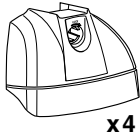
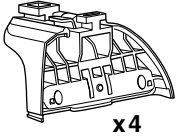

460R

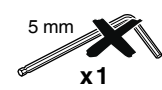
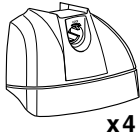
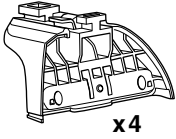

460

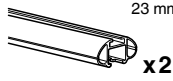
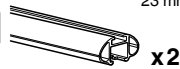
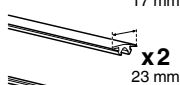
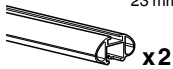
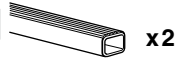
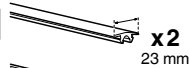
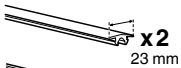
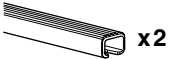
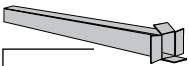
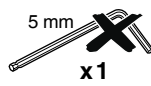
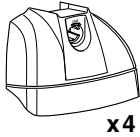
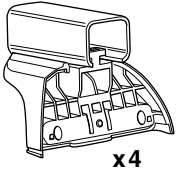

1

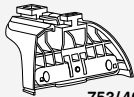

753/460R

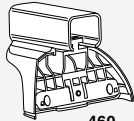

460

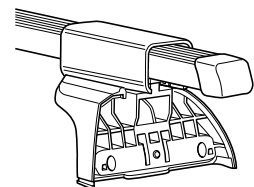
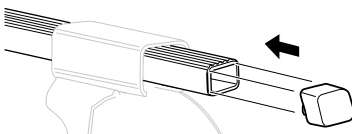
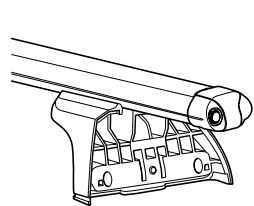
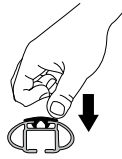
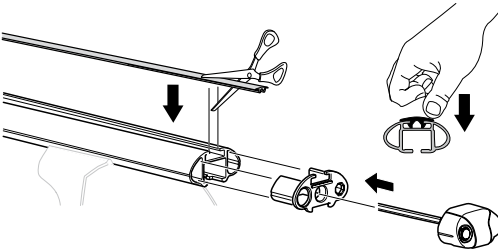
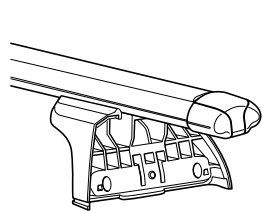
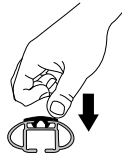
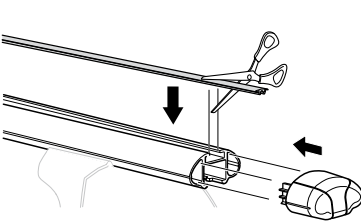
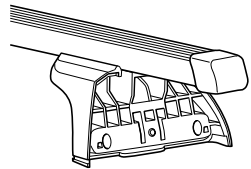
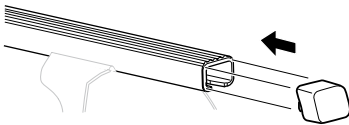
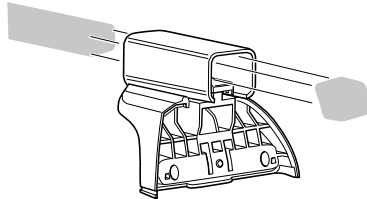
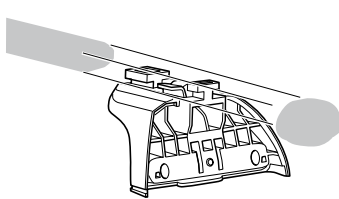

2

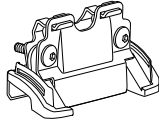

x 4



x 1

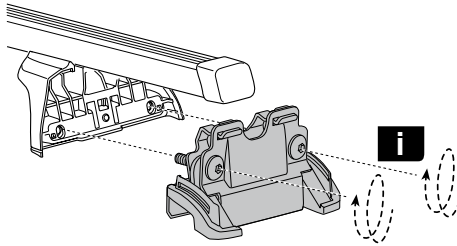
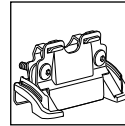
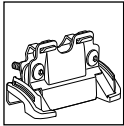
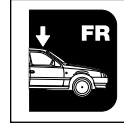
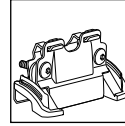
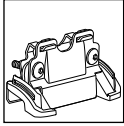

i

GB Only a few turns

D Nur wenige Umdrehungen

F Quelques tours uniquement

NL Slechts enkele slagen

I Solo qualche giro

E Sólo algunas vueltas

PT Noções básicas

S Endast några varv

FIN Vain muutama kierros

EST Ainult mõni pööre

LAT Tikai dažī apgriezieni

LIT Tik keli pasukimai

PL Wystarczy kilka obrotów

RU Достаточно нескольких оборотов

CZ Pouze několik otáček

SK Len niekoľko otáčok

SLO Le nekaj obratov

HR Samo nekoliko okreta

HU Csak néhány fordítás

GR Μόνο μερικές στροφές

TR Yalnız birkaç kez çevirm

中文 只有几个转向

한국어 두 세번만

日本語 数回転のみ

ไทย หมุนเพียงไม่กี่รอบ

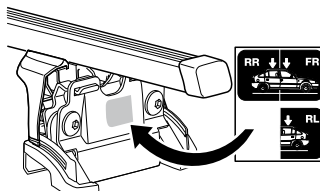

3

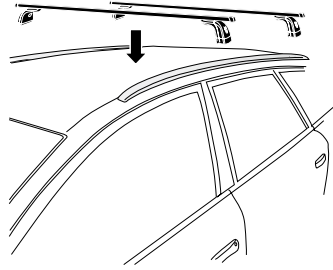
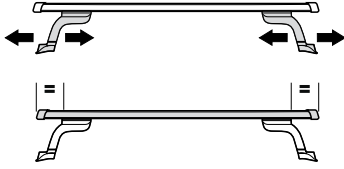

A

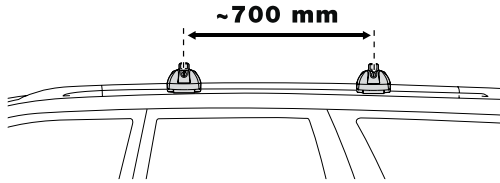

B

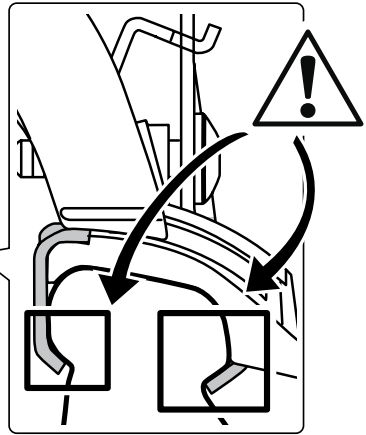
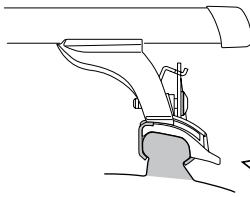
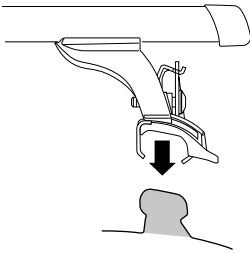

C

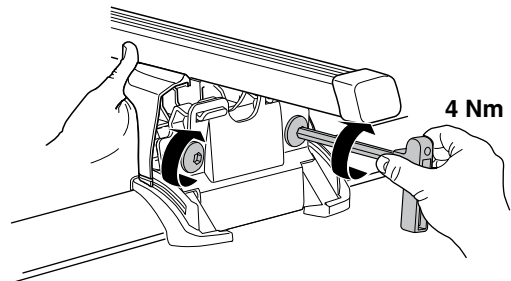
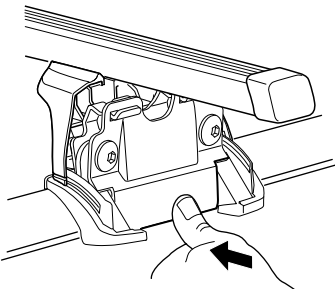
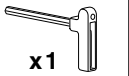

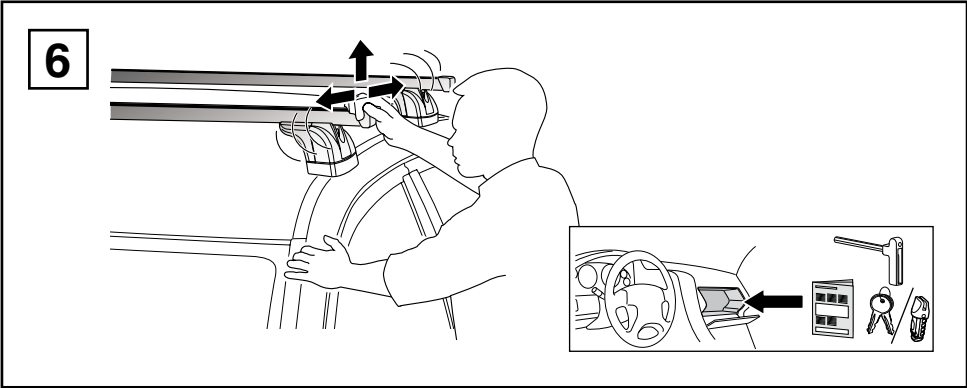
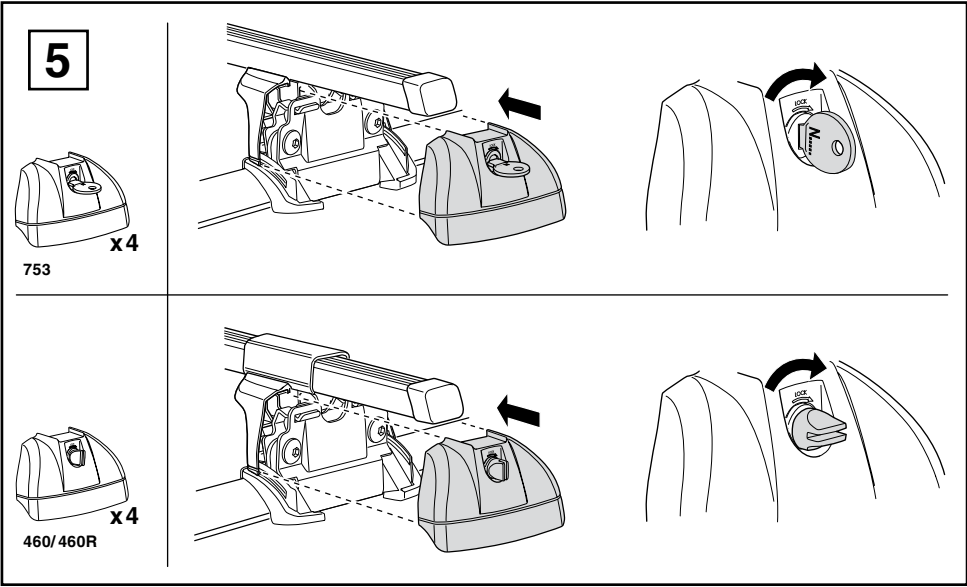
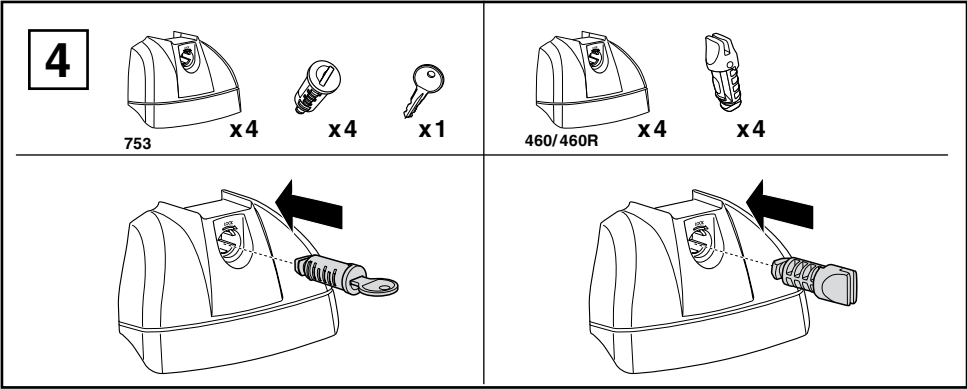

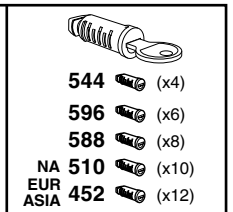
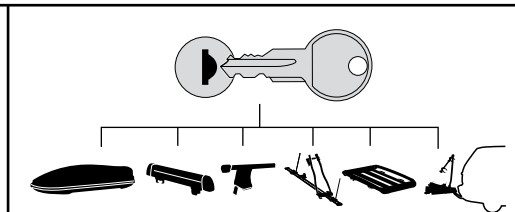
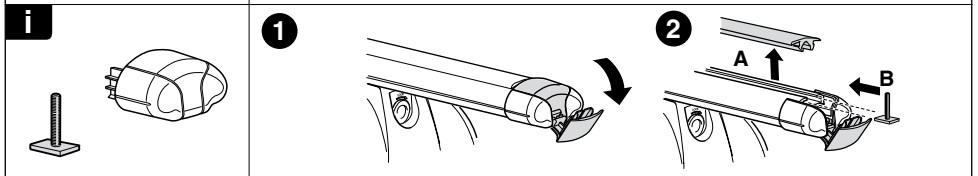
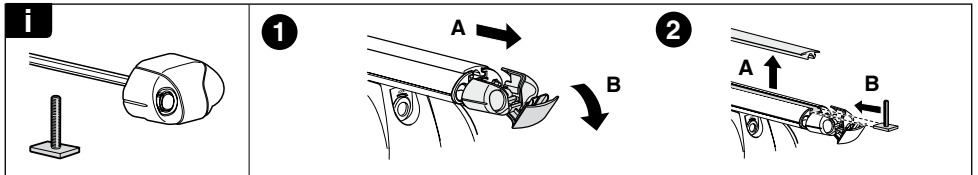
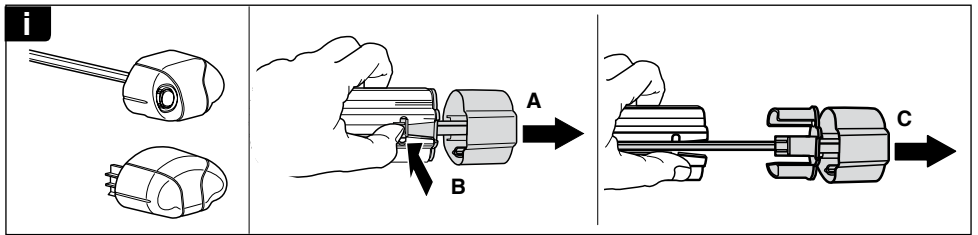
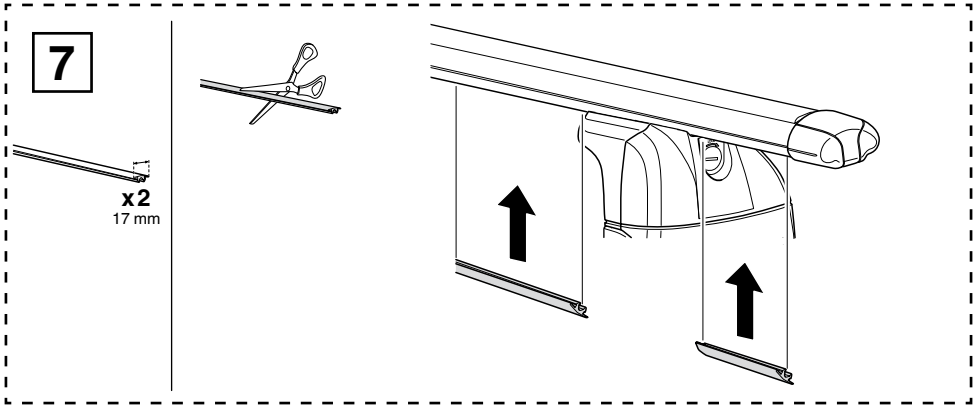

WW ▶ Thule Sweden AB, Box 69, 330 33 Hillerstorp, SWEDEN
 NA ▶ Thule Inc., 42 Silvermine Road, Seymour, Connecticut 06483, USA

info@thule.com
 customer.service@thule.com

www.thule.com