

Kit 4017

MITSUBISHI ASX, 5-dr SUV, 10-

This kit is only for vehicles with flush or integrated side railing.



460R
753

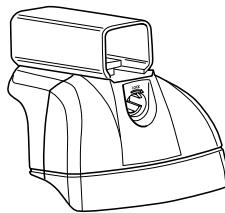

460

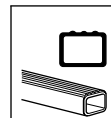

Kit



753



x4



x4



x4



16 mm

x8



5 mm

x1



x4



x1

460R

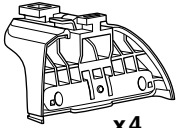

x4



x4



x4



16 mm

x8



5 mm

x1



x4

460

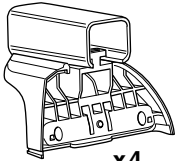

x4



x4



x4



16 mm

x8

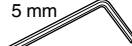

5 mm

x1



x4

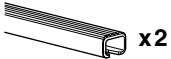

x2



x2

23 mm



x2

17 mm



x2

23 mm

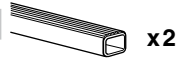

x2

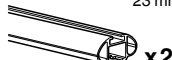

x2

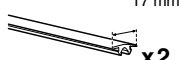

x2

23 mm

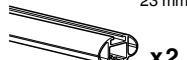

x2



x4

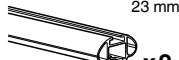

x2

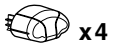

x4



x4

1



753/460R



460

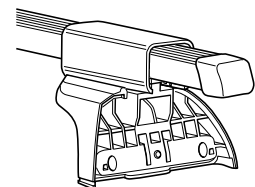
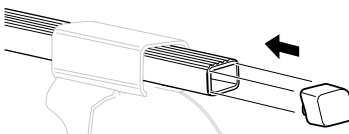
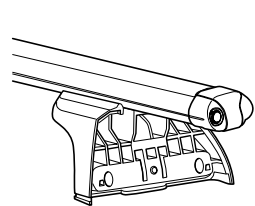
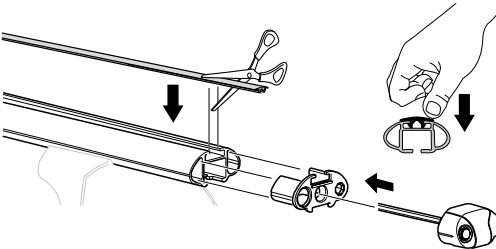
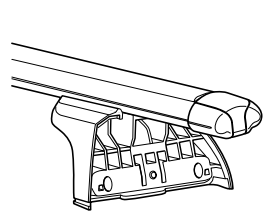
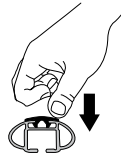
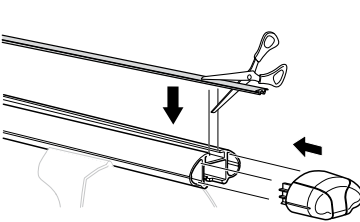
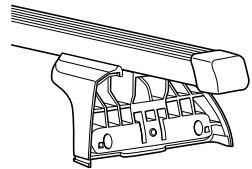
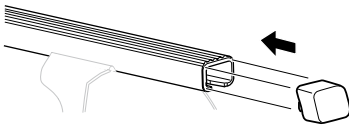
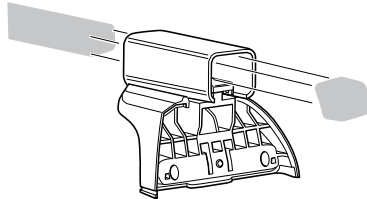
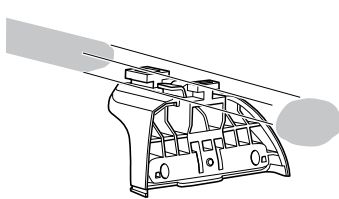

2

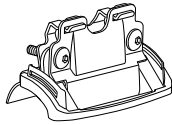

x 4



x 1

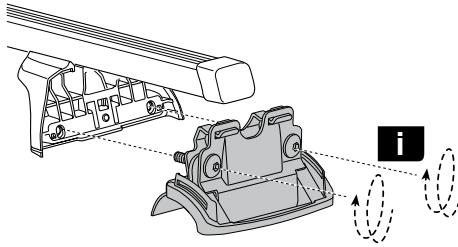
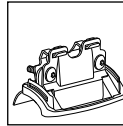
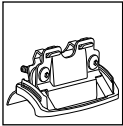
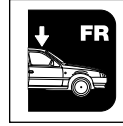
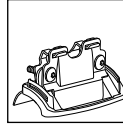
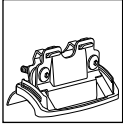

i

GB Only a few turns

D Nur wenige Umdrehungen

F Quelques tours uniquement

NL Slechts enkele slagen

I Solo qualche giro

E Sólo algunas vueltas

PT Noções básicas

S Endast några varv

FIN Vain muutama kierros

EST Ainult mõni pööre

LAT Tikai dažī apgriezieni

LIT Tik keli pasukimai

PL Wystarczy kilka obrotów

RU Достаточно нескольких оборотов

CZ Pouze několik otáček

SK Len niekoľko otáčok

SLO Le nekaj obratov

HR Samo nekoliko okreta

HU Csak néhány fordítás

GR Μόνο μερικές στροφές

TR Yalnız birkaç kez çevirm

中文 只有几个转向

한국어 두 세 번만

日本語 数回転のみ

ไทย หมุนเพียงไม่กี่รอบ

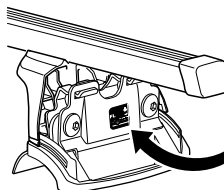

3

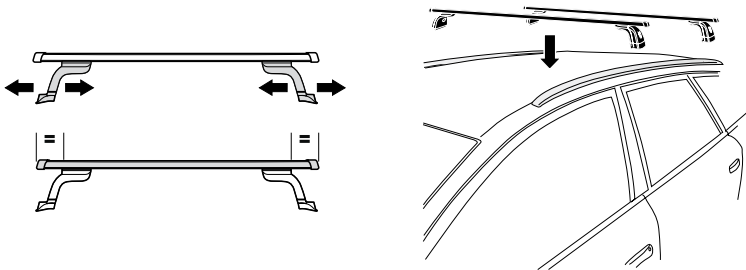

A

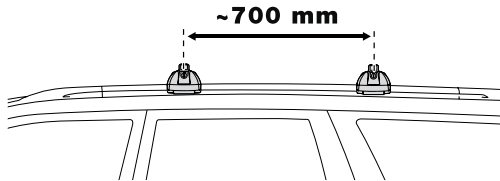

B

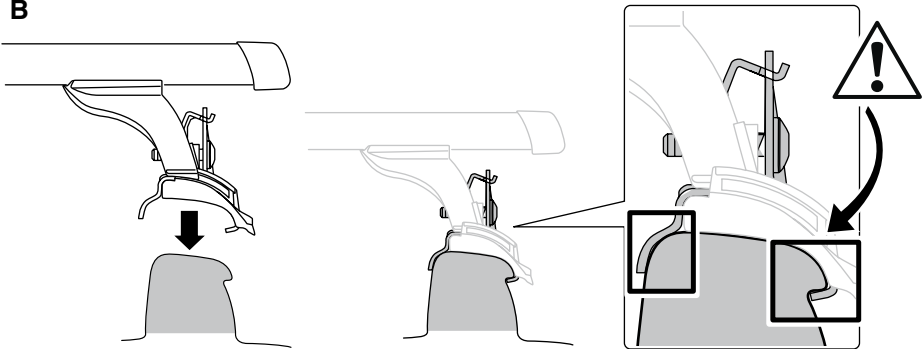

C

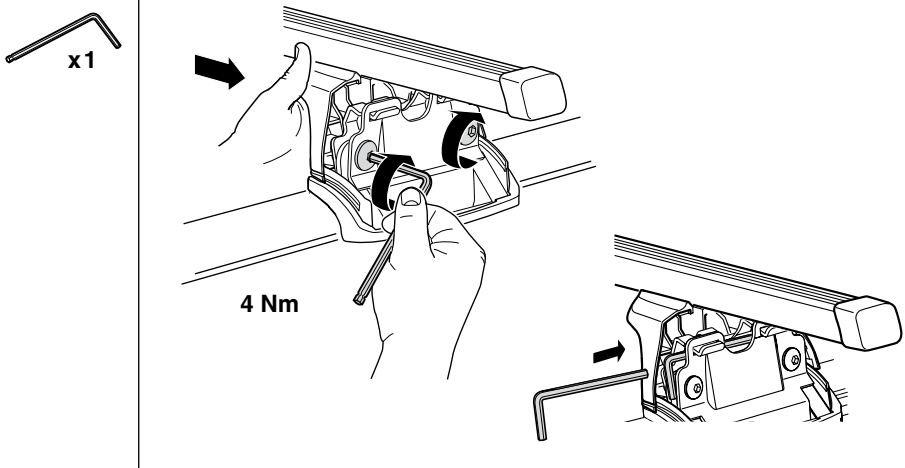

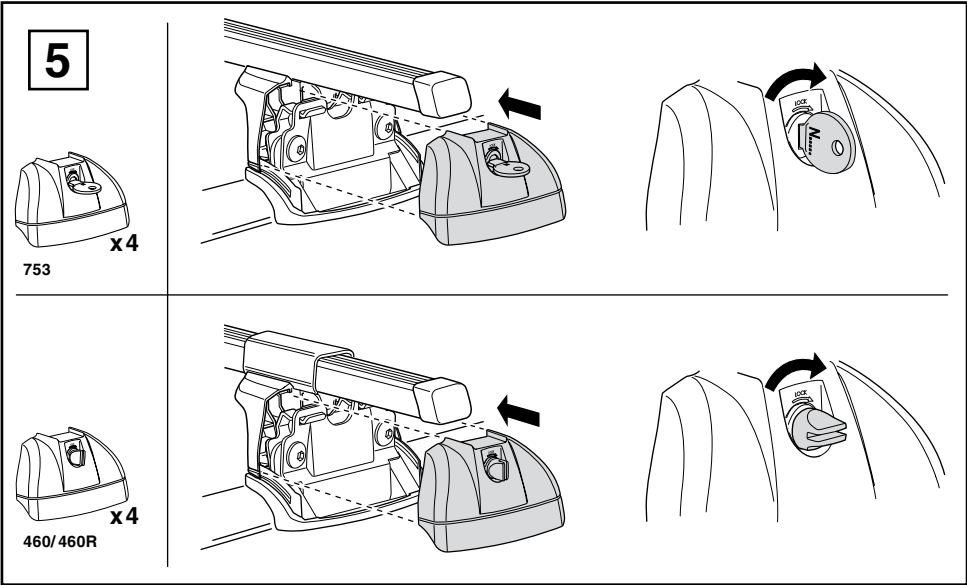
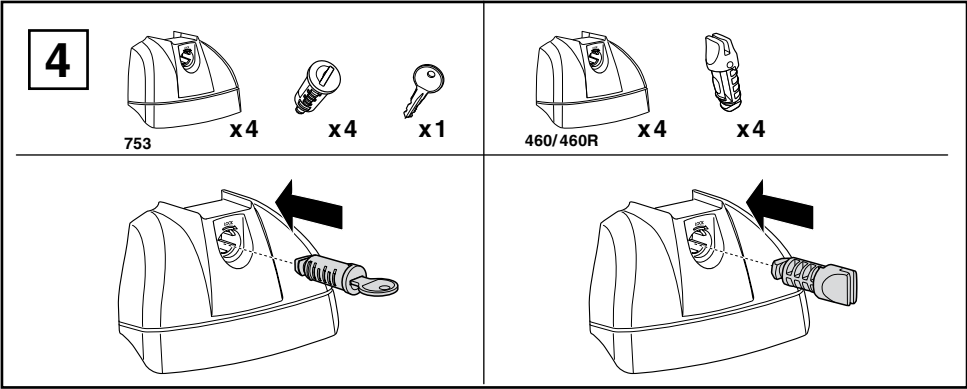

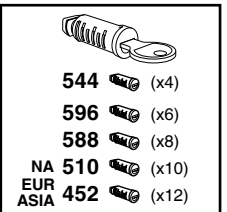
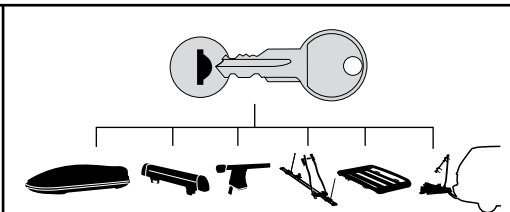

WW ▶ Thule Sweden AB, Box 69, 330 33 Hillerstorp, SWEDEN

NA ▶ Thule Inc., 42 Silvermine Road, Seymour, Connecticut 06483, USA

info@thule.com

customer.service@thule.com

www.thule.com